



CLEANCODE EV 1

INK JET PRINTERS
INSTALLATION AND OPERATION MANUAL

Open Date Equipment Ltd.

8 & 9 Puma Trade Park

Morden Road

Mitcham

Surrey

CR4 4DG

UK

Tel: +44 (0)20 8655 4999

Email: sales@opendate.co.uk

www.opendate.co.uk

This manual is for use in operating and maintaining the CLEANCODE EV 1 Ink Jet Printer. This includes various optional features, which may not be included in your basic model printer. For basic start-up instructions, please refer to PART 1 Installation Procedures.

All rights reserved. No part of this document may be reproduced, stored on a retrieval system, or transmitted in any form, or by any means electronic, mechanical, photocopying, recording or otherwise, without the prior permission of Open Date Equipment Ltd.

Open Date Equipment Ltd. has a policy of continual product improvement. The Company therefore reserves the right to modify the information contained in this manual without prior notice.

ALL PRINT CARTRIDGES SUPPLIED BY OPEN DATE EQUIPMENT LTD. ARE FACTORY TESTED AND PROFILED TO PRODUCE AN OPTIMUM AND CONSISTANT CODE. USING OTHER THAN AUTHORISED CARTRIDGES WILL CAUSE UNDESIRABLE RESULTS.

EACH FLASH DATA CARD IS PROFILED EXPLICITELY FOR ITS' INTENDED PRINTER, AND IS SECURITY LOCKED PROHIBITING USE IN OTHER THAN THE ORIGINAL PRINTER FOR WHICH IT WAS PURCHASED. KEEP ALL UPGRADE CARDS IN A SECURE PLACE.

CLEANCODE EV II IS A FULLY FEATURED MODEL WITH VARIABLE FIELD PROGRAMMING AND BARCODE CAPABILITIES.

INDEX**Part 1: Installation Procedures**

Installing and Cleaning the EV 1 Printing System	1
Mounting on a Production Line	1
Earth Strap Installation	2
Input Power Connection and Modification	2
Installing the Print Cartridge	3
Connecting the Controller to the Carriage	4
Configuring the Printer	5
System Reset	6
Multiple Printheads	7
CleanCode EV 1 Quick Start	8
Changing Language Prompts	8
Enabling Print Mode	8
Head Select Mode	8
Entering a Message	9
Storing a Message (Option Pack 1, 1.5, 2 or 3 only)	10
Loading a Message (Option Pack 1, 1.5, 2 or 3 only)	11
CleanCode EV 1 Quick Set-Up	12

Part 2: Operation Procedures

Overview	13
Controller and LCD	13
Keypad Key Descriptions	14
Turning the Print Station on for the First Time	15
Checking System Information	15
Checking Loaded Fonts	15
Changing System Date and Day of Week Codes (Option Pack 2 Installed)	16
Changing System Time and Date Roll-Over Time (Option Pack 2 Installed)	17
Programming	19
Definitions	19
Modes of Operation	19
Print Mode and Stopped "Command" Mode	19
Menu Structure	20
F1 Menu	21
1: Character Spacing	21
2: Ext. Encoder	21
3: Date Offset (Option Pack 3 only)	22
F2 Menu	23
1: Direction	23
2: Print Inverse	23
3: Product Detect	23
4: Auto Repeat (Option Pack 1, 2 or 3 only)	24
F3 Menu	25
1: Product Count (Option Pack 3 only)	25
2: Shift Code (Option Pack 3 only)	26
3: Date Format	27
4: Time Format	29
F4 Menu	30
1: Language	30
2: Ink Supply	30
3: Set Unit I.D.	31
4: Load Card	32
Loading Fonts (Menu Select 1)	32
Loading Logos (Menu Select 2)	33
Loading Options (Menu Select 3)	33
Setting Print Delay and Line Speed	35
Setting Line Speed	35
Setting Print Delay	36

Input, Edit or Delete Messages	37
Variable Field Format Printing (Option Pack 1, 2 or 3 only)	43
Password Protection (Option Pack 1, 2 or 3 only)	45
Message Storage (Option Pack 1, 2 or 3 only)	46
Storing a Message	46
Recalling a Stored Message	46
Part 3: Maintenance Procedures	47
Periods of Shut Down	47
Short Periods of Shutdown	47
Long Periods of Shutdown	48
Print Cartridge Maintenance	49
Exploded View of the Print Cartridge	51
Part 4: Troubleshooting and Repairs	52
Faults	52
Part 5: Parts List and Options	53
Part 6: Communications Protocol	54
Description	55
Data Word Definition	55
Baud Rate	55
Definitions	55
Cabling for EV Link Environment	55
Hardware Interface	55
Physical Connections – RS485 Print Carriage	56
Protocol Format	56
CleanCode EV Printable Character Set	56
Software Protocol	57
Error Codes	57
Commands	58
Special Field Objects	64
Part 7: Option Jumpers and Cabling	74
Option Jumper Descriptions	74
VSEL J7	74
Ensel J9	74
PRSEL J10	74
Jumper Locations	75
Option Cabling Descriptions	76
Part 8: Specifications	78
Printer Specifications	78
Print Characteristics	78
Controller	78
Print Carriage	78
Environmental Conditions	78
General	78
Default Settings	79

INSTALLATION AND OPERATION MANUAL

PART 1: INSTALLATION PROCEDURES

INSTALLING THE CLEANCODE EV 1 PRINTING SYSTEM

Caution should be taken while installing the CLEANCODE EV printing system on to your equipment. Open Date Equipment Ltd. has taken every precaution to ensure a safe and accurate instruction set to guide the installer through the installation process.

Follow the operational guidelines in the installation procedures.

VERIFY THAT YOUR EQUIPMENT IS IN PROPER OPERATING CONDITION.

LOCATE A CONVENIENT POSITION ON YOUR EQUIPMENT. CLEANCODE EV II REQUIRES 115mm OF SPACE ON THE PRODUCTION LINE.

FOLLOW THE INSTALLATION PROCEDURES.

CAREFULLY READ ALL INSTALLATION PROCEDURES BEFORE PROCEEDING.

INSTALL THE PRINTING SYSTEM ONTO YOUR EQUIPMENT. THERE IS NO EXTRA HARDWARE REQUIRED OTHER THAN THAT SUPPLIED IN THE INSTALLATION KIT.

MOUNTING ON PRODUCTION LINE



Locate the supplied mounting template and affix in a convenient location on the production line. Spot and drill both mounting holes for an M8 screw. NOTE: the user may also thread the side of the conveyer using an M8 tap.

Fasten the mounting bracket to the conveyer using the supplied mounting hardware and ensuring that the supplied ground strap is

located securely beneath either of the two mounting bolts, and that conductivity to earth ground is less than 1 ohm. This ensures a proper path for static discharge, should the need arise.

GROUNDING STRAP INSTALLATION

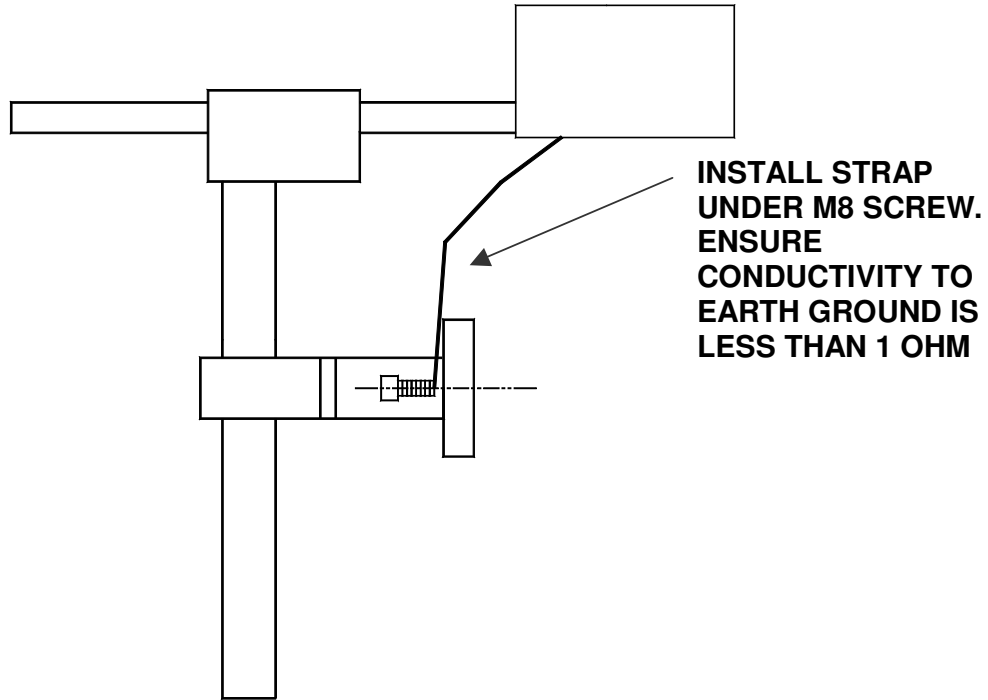

INPUT POWER CONNECTION AND MODIFICATION

Insert the power plug to the available power source. The supplied power supply will be universal and will auto detect 100/240 VAC 50-60Hz.

No other adjustments are necessary.

INSTALLING THE PRINT CARTRIDGE

Remove the protective film from the face of the print head and retain the film. This protective film may be re-applied to store partially used cartridges. If it is necessary to remove the print head and store for a long period of time, it is best to re-apply the plastic film, and place the cartridge in a closable plastic bag. Rotate the Print Head Release mechanism to the rear of the print head so that it is free for insertion of the print cartridge. Push the print cartridge in and down to insert it into the print carriage. Gently lift the locking arm and press forward against the print cartridge. A snap will be felt as the locking mechanism presses the cartridge into the correct position.

NOTE: EACH PRINT CARTRIDGE HAS BEEN PROFILED AT THE FACTORY. THIS PROCEDURE DETERMINES THE OPTIMAL OPERATING CHARACTERISTICS FOR EACH INDIVIDUAL CARTRIDGE. USING ANY OTHER PRINT CARTRIDGE WILL HAVE UNDESIRABLE RESULTS.

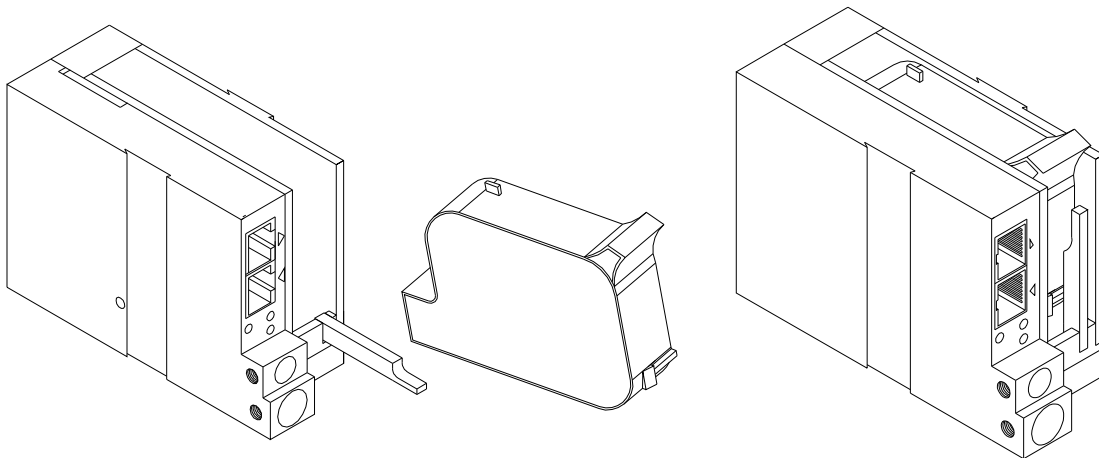

NOTE: WHEN A NEW CARTRIDGE IS INSTALLED, BOTH THE RED AND GREEN LIGHT WILL FLASH TWICE INDICATING A CORRECT INSTALLATION. THE USER MUST REMEMBER TO RESET THE INK LEVEL UNDER THE F4 FUNCTION KEY MENU.

CONNECTING THE CONTROLLER TO THE CARRIAGE

Connect the Controller to the print carriage using the supplied 900mm interconnect cable supplied with the Printing System. The cable is a standard RJ50 (10 conductor). Longer cables are available as required.

Connect either end of the cable to the Carriage Assembly and securely lock in place. **NOTE: THE CONNECTOR MUST BE PLUGGED INTO THE INPUT RJ50 CONNECTOR LOCATED ADJACENT TO THE LED'S AND MARKED WITH AN ARROW POINTING TO THE CONNECTOR.** A click will be heard when the connector is in the appropriate position. Connect the free end to the Controller Assembly and ensure connector is securely seated.

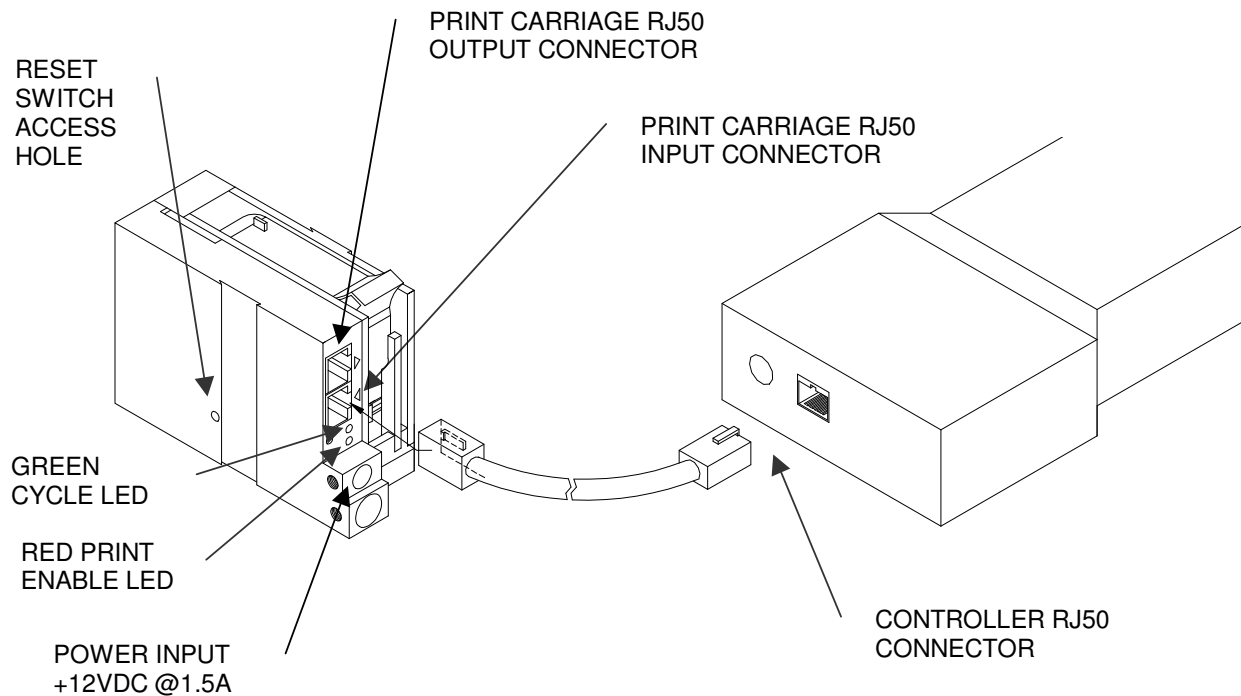

CAUTION:

NOTE ORIENTATION OF THE CONNECTORS. DO NOT FORCE CONNECTORS INTO POSITION. SECURELY LATCH (CLICK) INTO POSITION.

CONTROLLER MUST PLUG INTO THE PRINT CARRIAGE RJ50 INPUT CONNECTOR FOR PROPER OPERATION. THE PRINT CARRIAGE RJ50 OUTPUT CONNECTOR IS USED EITHER FOR CONNECTION TO THE NEXT PRINTER ON A NETWORK OR FOR EXTERNAL PRODUCT OR EXTERNAL ENCODER INPUT.

THE POWER INPUT CONNECTOR MUST BE SECURELY INSERTED INTO THE PRINT CARRIAGE. UPON PROPER INSERTION BOTH THE RED AND GREEN LED'S WILL FLASH INDICATING PROPER CONNECTION.

CONFIGURING THE PRINTER

To verify the current operating software press the **STOP PRINT**  key.

Press the **V** key

```
CONTROLLER 7.08
PRINTER 2.08J
PRINTER SN XXXXXX
EXIT ANY KEY
```

The first line indicates the version of the controller software

The second line numeric indicate printer software version and the letter is the firmware version of the printer. The '+' (s) following indicate options installed:

```
+ _ _ _ = Option 1
_ _ + _ = Option 1.5
+ _ + _ = Option 1 and Option 1.5
+++ _ = Option 2
++++ = Option 3
```

The third line indicates the serial number of the printer

SYSTEM RESET

Soft Reset:

There are two types of resets available in the CleanCode EV II printing system. The first type of reset is a SOFT RESET.

**ERASE STORED
MESSAGES
YES OR NO Y/N**

Pressing the R key while applying power to the unit will display the reset command mode

CAUTION: A response of Y will delete all stored messages.

**RESET PRINT HEAD
YES OR NO Y/N**

The next screen to appear prompts the user to determine if a print head is to be restored to its default value.

CAUTION: ALL PRINT HEADS CONNECTED TO THE CONTROLLER WILL BE RESET TO FACTORY DEFAULT CONDITIONS. THIS INCLUDES RESETTING EACH UNIT ADDRESS TO 1. TO PREVENT THIS REMOVE ALL INTERCONNECTED PRINT HEADS EXCEPT FOR THE UNIT TO BE RESET FROM THE DATA LINK.

**ALL HEADS
WILL BE RESET
CONTINUE = X KEY
ANY OTHER EXITS**

Hard Reset:

The second reset is a hard reset. Disconnect the power cable. Insert a standard paper clip into the hole on the female dovetail side of the cabinet, and while holding the paper clip in place (a light click will be felt) re-apply the power connector.

This operation will reset the print carriage assembly to the factory default settings and clear any current message.

MULTIPLE PRINT HEADS

CLEANCODE EV printing systems have the ability to reside on a network. The network may contain from 1 to 32 print carriages connected via RJ50 cables. These cables are available in varying lengths depending on the application. Each mounting bracket can support up to 4 print carriages and would typically interconnect with a 150mm RJ50 data cable.

NOTE: Please address each unit individually as per page 32 prior to daisy chaining the printers. Special care must be taken to connect the output of the first print carriage to the input of the next print carriage.

When connecting multiple print carriages place no more than 2 stations on a side of the mounting bracket as shown.

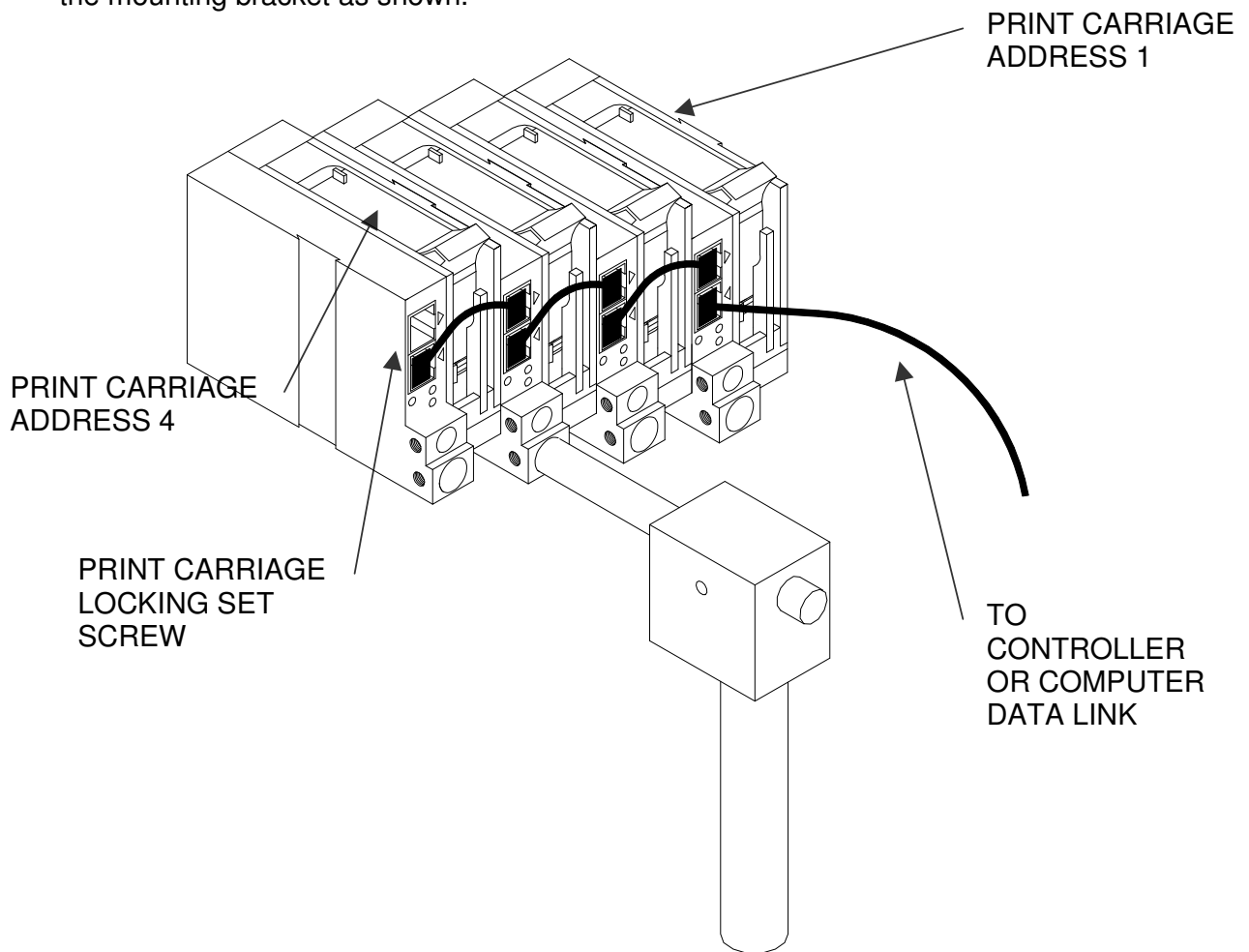

CLEANCODE EV 1 QUICK START

```
EV1 STOPPED
HD 1- ->SPEED=100
OPEN D
```





Connect the printer carriage to the appropriate power source.

Connect the controller to the carriage assembly. The controller derives power from the carriage.

On start-up the LCD will display as pictured.

CHANGING LANGUAGE PROMPTS

```
<-- SELECT -->
ENGLISH
```

Press the F4 key  and select  for LANGUAGE. Use the   keys to select the desired language and press the  to select the language.

ENABLING PRINT MODE





```
EV1 PRINTING
HD 1- ->SPEED=100
OPEN D
```



Press the GREEN PRINT key  to start printing

HEAD SELECT MODE

```
EV1 STOPPED
HD 1- ->SPEED=100
OPEN D
```

The hand held controller can program up to 32 print carriages on an RS485 data link. The factory default sets each print carriage to **ADDRESS 1**. Selection of another print head other than ADDRESS 1, press

the  key. Use the   keys to select the alternate print carriage number and press the  key. The print carriage whose address was selected will respond with the current message and appropriate parameters.

As an added convenience using the   will auto scan to find the next available head connected to

the environment

```
NO RESPONSE

ANY KEY TO EXIT
```

Accessing an address not associated with any print carriage will result in a no response message.

ENTERING A MESSAGE

STOPPED
HD 1- - >SPEED=120
EVOLU

Press the GREEN PRINT key 
The LCD display will change from PRINTING to STOPPED.



MESSAGE ENTRY
FONT 1 LINE
EVOLU

Press the GREEN EDIT key 

MESSAGE ENTRY
FONT 1 LINE

Press the BLUE F3 key  to delete the entire message

MESSAGE ENTRY
FONT 1 LINE
EXP 12/10/09

Press the BLUE FONT  key to select the desired font size and enter the text EXP 12/10/04
Press the ENTER key  to end the MESSAGE EDIT mode

PRINTING
HD 1- - >SPEED=120
EXP 12/10/09

Press the GREEN print enable key  to enter the print mode

STORING A MESSAGE (OPTION PACK 1, 1.5, 2 OR 3 ONLY)

STOPPED
HD 1- - >SPEED=120
EXP 12/10/09

Press the GREEN STOP PRINT KEY 
Note: In option pack 1 there is a maximum of 50 messages stored. Option pack 1.5 increases message storage to 99 messages.

MESSAGE # 1
PLEASE WAIT

Press the RED MESSAGE STORE key 
The LCD display will display the message storage screen
Use the  or  to select the desired storage location

MESSAGE # 1
MESSAGE STORED
EXP 12/10/09

Press the RED MESSAGE STORE KEY  a second time and the current message appears in the selected location and is stored.

STOPPED
HD 1- - >SPEED=120
EXP 12/10/09

Press the ENTER key  to return to the command prompt.



LOADING A MESSAGE (OPTION PACK 1, 1.5, 2 OR 3 ONLY)

STOPPED
HD 1- - >SPEED=120
EVOLU

Press the GREEN STOP PRINT KEY 
Note: In option pack 1 there is a maximum of 50 messages stored. Option pack 1.5 increases message storage to 99 messages.

MESSAGE # 1
PLEASE WAIT

MESSAGE # 1
EXP 12/10/09

Press the RED MESSAGE STORE key  and use the  or  keys to select the desired message

STOPPED
HD 1- - >SPEED=120
EXP 12/10/04

and press the ENTER  key

PRINTING
HD 1- - >SPEED=120
EXP 12/10/09

Press the GREEN print enable key  to enter the print mode

CLEANCODE EV 1 QUICK SETUP

Install a new cartridge. Press the following keys in order:



<p>REMAINING INK 100 % C NEW CARTRIDGE OTHER KEY EXIT</p>
--

To reset the ink level detector press

Each time a new print cartridge is installed the system automatically profiles the correct operating parameters for the new cartridge. These parameters set the required voltage and on time to produce consistent results without user intervention.

NOTE: USING OTHER THAN AUTHORISED CARTRIDGES MAY CAUSE UNDESIRABLE RESULTS.

Press the GREEN print enable key to enter the print mode

To set the LINE SPEED, press to put the system in the Printing mode. Set character width by



To set the PRINT DELAY press: to put the system in the Printing mode. Set print delay by



NOTE: Each increment or decrement changes the delay by the pre-defined amount.

You may continue to experiment with line speed and print delay until the desired code registration on the product is achieved.

PART 2: OPERATION PROCEDURES

OVERVIEW







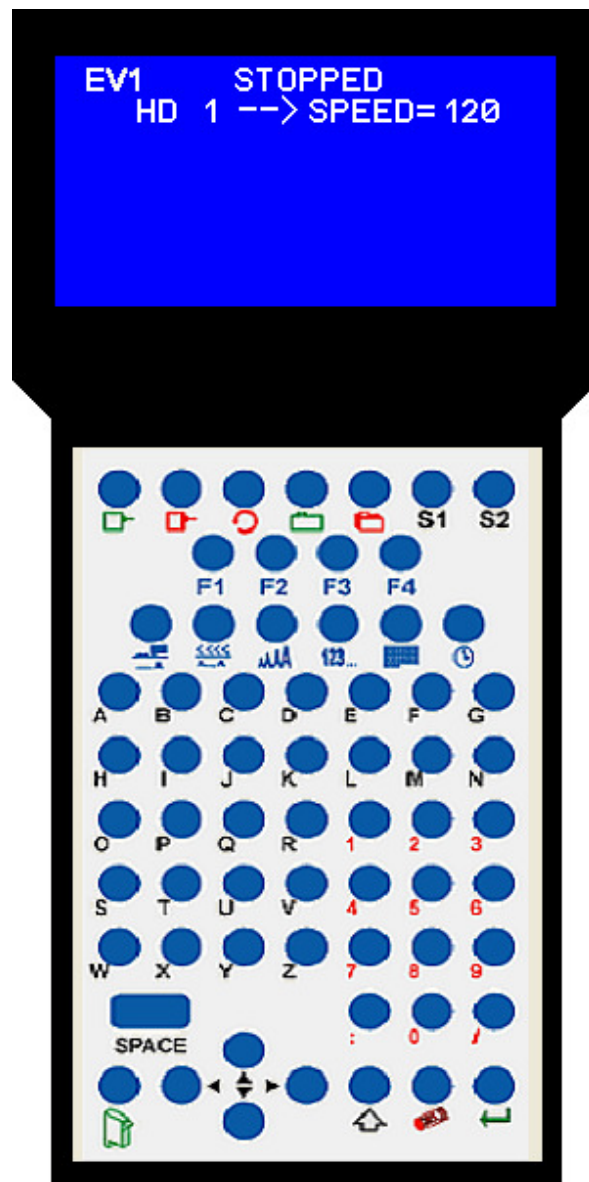









CONTROLLER AND LCD

The keypad on the print station, pictured here, contains 64 keys. The LCD will display various messages to assist in programming on the upper half of the display. The lower half of the display will show up to two lines of the entered print message.

The 4 keys on the top row are the function keys F1 through F4. They each consist of submenus for modifying various printer functions. Their specific menus are detailed later in this section.



KEYPAD KEY DESCRIPTIONS

	This is the manual cycle key. When in the Stopped mode, pressing this key causes the printer to print one code.
	This is the Print key. Use it to place the unit in the Print mode.
	This is the Purge key. Use it to purge ink for maintenance purposes. The unit must be in the Command mode to use this key.
	This is the Head Select key. Use it to select the address of the head to be communicated with.
	Use this arrow to decrease values, and use it to move the cursor in the message line while editing the message.
	Use this arrow to increase values and use it to move the cursor in the message line while editing the message.
	Use this arrow to move the cursor between the message lines while in Edit mode and building a message.
	Use this arrow to move the cursor between the message lines while in Edit mode and building a message.
	This key is the Message Storage key. Use it to store and to recall individual codes.
	This is the Delete key. Use it to backspace to delete a character when mistyped as well as to exit from certain menus.
	This is the Message Entry key. Use this key to enter the Message Entry mode, to input a code or to edit a code.
	This is the Date key. Use this key to enter the Date in Message Entry Mode (OPTION PACK 2). Change Date in STOPPED mode.
	This is the Time key. Use this key to enter the Time in Message Entry Mode (OPTION PACK 2). Change Time in STOPPED mode.
123...	This is the Sequence Number key. Use this key to enter the Sequence Number in Message Entry Mode (OPTION PACK 2).
	This is the Enter or Return key. When pressed, the unit will accept input and exit certain menus.
	This key selects the Print Delay in COMMAND mode and Offset Date in EDIT mode (OPTION PACK 3)
	This key selects the Line Speed in COMMAND mode and the shift code in the EDIT mode (OPTION PACK 3)
	This key selects the Font size in the EDIT mode. In the COMMAND mode pressing this key displays the current fonts loaded in the print head.
S1	Pressing this key while in the Message Entry mode accesses special characters.
S2	This key is reserved for special customer Logos.

TURNING ON THE PRINT STATION FOR THE FIRST TIME

```

STOPPED
HD1- - >SPEED=120
EVOLU

```

To turn the print station on insert the power jack into the DC power connector.

There is no on/off switch.

The first time the print station is turned on, as received from the factory, the LCD will look like the illustration on the left. Each line gives important information regarding the system:

The Top line indicates the operating mode of the unit: "STOPPED" when in Command mode, " PRINTING" when in Print mode, and "MESSAGE ENTRY" when in message entry.

The 2nd line shows the print head currently selected, the direction of travel for the product and the programmed SPEED.

The lower half two lines of the display shows the message entered for printing. This may represent one or two lines of code.

CHECKING SYSTEM INFORMATION

```

CONTROLLER 7.08
PRINTER 2.08J +++
PRINTER SN284955
ANY KEY TO EXIT

```

Verify system information by pressing the V key on the hand held controller keyboard. The LCD screen will display the software, firmware, serial number and options enabled. Enabled options are indicated on the second line as a series of + characters where the first + indicates option pack 1, the second +

indicates option pack 1.5 and the last + indicates option pack 2.

CHECKING LOADED FONTS

```

ACTIVE FONTS
2 LINE fontname
1 LINE fontname
ANY KEY TO EXIT

```

Press the FONT **AAA** key in the COMMAND mode to check what fonts are currently loaded in the print head.

CHANGING SYSTEM DATE AND DAY OF WEEK CODES (OPTION PACK 2 INSTALLED)

**PRESENT SETTING
ANY CHANGES Y/N
01/04/00**

When the unit is in the STOPPED mode pressing the DATE  key allows the user to change the system date. If there are no changes press the N key to return to the STOPPED mode. Press the Y key to change the date.

**PRESENT SETTING
ANY CHANGES Y/N
01/04/00
ENTER MONTH-**

The system will prompt the user first for the Month (enter 2 digits), then the Day (2 digits) and finally the year (2 digits).

**PRESENT SETTING
ANY CHANGES Y/N
01/04/00
ENTER DAY-**

**PRESENT SETTING
ANY CHANGES Y/N
01/04/00
ENTER YEAR-**

**<-- SELECT -->
DAY OF WEEK- 1**

After the date is entered the system requests the actual date day of week. This parameter is usually set to 1 for Sunday, 2 for Monday etc.

**DAY FORMAT
1= NUMERIC
2= LETTERS**

The day of the week can be entered into a message as either a number 1-7 or as a letter A-G. The day of the week is entered into a message by pressing the  key while in the MESSAGE ENTRY mode.

**PRESENT SETTING
ANY CHANGES Y/N
04/23/05**

After the data is entered the system displays the currently entered date and pressing the N key returns the user to the STOPPED mode, or press Y to the correct the date.

CHANGING SYSTEM TIME AND DATE ROLL OVER TIME (OPTION PACK 2 INSTALLED)

TIME SETTINGS
 1= SET TIME
 2= DATE CHANGE TIME

When the unit is in the STOPPED mode pressing the TIME  key allows the user to change the system date. If there are no changes press the N key to return to the STOPPED mode.

PRESENT SETTING
 ANY CHANGES Y/N
 23:05

Select the N key if the time is correct and return to the STOPPED mode.

PRESENT SETTING
 ANY CHANGES Y/N
 23:05
 ENTER HOURS -

Press the Y key to change to the correct time. Enter the correct hours (2 digits) followed by the correct minutes (2 digits). The screen displays the corrected time. Press the Y key to make further changes or N key to return to the STOPPED mode.

PRESENT SETTING
 ANY CHANGES Y/N
 23:05
 ENTER MINUTES -

Notice the time is in 24-hour format.

PRESENT SETTING
 ANY CHANGES Y/N
 13:50

TIME SETTINGS
 1= SET TIME
 2= DATE CHANGE TIME

The Date Change option is enabled by selecting option 2. This feature allows the date to roll over at a specified time other than 12:00AM (midnight). For example if the start of a new shift day occurs at 6:00AM the date will be changed each day at 6:00AM.

DATE TIME CHANGE
 ANY CHANGES Y/N
 00:00

Selecting Y allows changing of the roll over time. Setting this parameter to 00:00 disables the function.

**DATE TIME CHANGE
ANY CHANGES Y/N
00:00
ENTER HOURS -**

Similar to entering the time enter first the hours then at the next prompt enter the minutes. Remember the time is entered in military time.

**DATE TIME CHANGE
ANY CHANGES Y/N
00:00
ENTER MINUTES -**

Entering 06:00 sets the date change time at 6:00AM.

**RESET CLOCK

ENTER HOURS -**

Enabling this function requires resetting the current correct time.

**RESET CLOCK

ENTER MINUTES -**

Enter both the current time in hours and minutes. This resets the correct time and establishes a new Date Rollover Time.

PROGRAMMING

DEFINITIONS

There are two parts to programming the CleanCode EV 1 ink jet printer,

- Setting the operations parameters, (character width, delay, etc.) and
- Building the message.

MODES OF OPERATION

The system operates in 3 basic modes. They are: Print Mode, Command Mode, and Message Entry Mode.

In Print Mode the majority of the keys on the keypad are disabled to avoid inadvertent changes. When in Print Mode the Top line of the LCD will display **PRINTING**.

The Command Mode is used to change the functions of the printer. When in the Command Mode the display will show **STOPPED** on the top line.

The Message Entry Mode is used to create or modify printable codes, when in this mode the top line of the display will show **MESSAGE ENTRY**.

PRINT MODE AND STOPPED “COMMAND” MODE

<p>PRINTING HD1- - >SPEED=120 EVOLU</p>

When in the Print mode the screen will look like the screen on the left. When PRINTING is seen on the LCD, the unit will print as product passes in front of the carriage assembly. To enter Print mode, press .

<p>STOPPED HD1- - >SPEED=120 EVOLU</p>
--

When in the Command Mode the screen looks like the illustration at left. When STOPPED the printer will not print when product is moved past the carriage assembly.

In Command mode, access can be made to the menus under the function keys, **F1** through **F4** icon control keys plus access to Message Entry Mode. To enter Command mode, press .

MENU STRUCTURE

In the Command mode, access is allowed to the menu structure for basic parameters. The menus reside within the function keys, **F1** through **F4**. In order to select one of the parameters, press the number key that corresponds to the desired parameter.

F1

The **F1** key, when pressed, brings up the menu as shown below.

**1=CHAR. SPACING
2=EXT. ENCODER
3=DATE OFFSET**

No. 3 IS VALID IN OPTION PACK 3 ONLY

F2

The **F2** key, when pressed, brings up the menu as shown below.

**1=DIRECTION
2=PRINT INVERSE
3=PRODUCT DETECT
4=AUTO REPEAT**

F3

The **F3** key, when pressed, brings up the menu as shown below.

**NOT AVAILABLE

ANY KEY TO EXIT**

**SCREEN WITHOUT OPTION PACK 2 OR 3
INSTALLED**

**1= PRODUCT COUNT
2= SHIFT CODE
3=DATE FORMAT
4=TIME FORMAT**

No. 1 IS VALID IN OPTION PACK 3 ONLY
No. 2 IS VALID IN OPTION PACK 3 ONLY
No. 3 IS VALID IN OPTION PACK 2 OR 3
No. 4 IS VALID IN OPTION PACK 2 OR 3

F4

The **F4** key, when pressed, brings up the menu as shown below.

**1=LANGUAGE
2=INK SUPPLY
3=SET UNIT I.D.
4=LOAD CARD**





F1 MENU

1=CHAR. SPACING
2=EXT. ENCODER
3=DATE OFFSET

Place the unit in the Command mode and press . The screen shown to the left is produced. Press the correct number to make changes to that parameter. Those selections designated as NOT AVAILABLE will not respond to selection. They are reserved for future system expansion.

1 = CHARACTER SPACING:

< - - SELECT - - >
 # OF SPACES- 1

This parameter controls the amount of space between characters in the code. Spacing can be varied from 1 to 25 columns. Use this control to make printed codes more legible when code is compressed. Press the  then press  or  to change the value. Press 



once the desired value is displayed.

2 = EXT. ENCODER:

ENCODER
1=INTERNAL
2=EXTERNAL

Press  to select internal time base. This parameter controls the source of the time base used for printing. Each vertical column printed requires a signal necessary to produce a character representative of the line speed of the production line. The printer can be set to produce a perfect aspect ratio character (300 dpi

vertical and horizontal) or compressed by setting the print head line speed faster than the actual line speed, or expanded by changing the internal speed slower than the actual line speed.

In the event there is an acceleration or deceleration to the production line, or there is a requirement to guarantee accurate aspect ratio, such in the case of barcodes, an external encoder is necessary. Press  to select external encoder. While external encoder is selected the LINE SPEED key  will adjust the expansion and compression of the printed message. NOTE: WHEN PRODUCING BARCODES IT IS NECESSARY TO PRODUCE A PERFECT ASPECT RATIO CHARACTER.

Swath height is 0.500 (1/2") / 150 vertical dots = 0.0033" between vertical dots
 Therefore to print a perfect aspect ratio character requires an encoder pulse every 0.0033". The encoder range adjustment is from 0 to 7 and assuming the mean is a count of 4 then by connecting an encoder that produces a pulse for each 0.000825" the correct character aspect ratio can be achieved. This allows either compression or expansion of the printed text.

3 = DATE OFFSET: (OPTION PACK 3 ONLY)

**DATE OFFSET
USE KEYS 0->9
OF DAYS = 100**

This selection is only available with option pack 3 installed. This allows the user to preset the number of days used in the date offset calculation to a maximum of 999 days. The format of the date offset can be different than a normal date and may be set with the F3 #3 option DATE FORMAT.

F2 MENU

1=DIRECTION
2=PRINT INVERSE
3=PRODUCT DETECT
4=AUTO REPEAT

Place the unit in the Command mode and press **F2**. The screen shown to the left is produced. Press the correct number to make changes to that parameter

NOTE: OPTION 4 ONLY APPEARS IF OPTION PACK 1 OR GREATER IS INSTALLED

1 - DIRECTION:

< - - SELECT - - >
LINE DIRECTION

< - - - -

The arrow shown on the LCD's third line screen should agree with the direction of product travel.

Press **▶** or **◀** to change direction. Press **↩** for the unit to accept the change.

2 - PRINT INVERSE:

CODE ORIENTATION
1 = NORMAL PRINT
2 = UPSIDE DOWN

This parameter allows the code to print right side up or upside down. Pressing **2** will produce the following screen. Press **1** for normal print or **2** for upside down codes. Save the choice by pressing **↩**. Look for the change of direction on

the imprint.

3 - PRODUCT DETECT:



PRODUCT DETECT
1 = INTERNAL
2 = EXTERNAL

This menu selection allows the user to select the source of the product detect feature. Press **1** and then **↩** to use the internal product detect sensor located at the front of the print carriage just below the print cartridge. If it becomes necessary to sense

a portion of the product not directly in front of the print head then an external product detect sensor must be used. This setting also allows the EV 1 to be controlled from other sources, like a PLC. When external product detect is selected the user must also change the jumper option within the print head. Refer to the OPTION SELECT section for proper use.

4 - AUTO REPEAT: (OPTION PACK 1, 2 OR 3)

< -- SELECT -- >
REPEAT TIME= 0

This option enables the unit to continuously print repeated codes at specified time intervals along the entire length of the product. A time of 0 disables the Auto Repeat option. Use  or  to change the repeat time. Each number in the time delay adds or subtracts a distance equivalent to the pre-defined setting. Save your choice by pressing . The maximum repeat spacing is 255 counts where each count is equal to 16 character columns or 0.053". This allows for a total displacement of 13.46". Setting a print delay that uses the same mathematical equation can increase this number. Thus a total displacement of 26.92" can be realised.

F3 MENU

1= PRODUCT COUNT
2= SHIFT CODE
3=DATE FORMAT
4=TIME FORMAT

1 – PRODUCT COUNT: (OPTION PACK 3 INSTALLED)

PRODUCT COUNT
CHANGES Y / N OR C
08:00 - - > 17:00
COUNT = 000000

The product counter is a non-printable entity, and must be read after the end of the set time period. The counter indicates each print cycle sensed by the external photo eye. Depressing the **C key** may clear the counter.

If there are no changes press the **N key**.

PRODUCT COUNT
START TIME
08:00 - - > 17:00
ENTER HOURS-

To change the settings depress the **Y key**.
All times are in Military Time 00:00 to 23:59 hours.

PRODUCT COUNT
START TIME
08:00 - - > 16:00
ENTER MINUTES-

Enter the start time HOURS.
At the next screen prompt enter the start time MINUTES

PRODUCT COUNT
STOP TIME
08:00 - - > 16:00
ENTER HOURS-

The system then prompts the user for the STOP TIME.

PRODUCT COUNT
STOP TIME
08:00 - - > 16:00
ENTER MINUTES-

Enter both the stop time HOURS and then the MINUTES.

PRODUCT COUNT
CHANGES Y / N OR C
08:00 - - > 17:00
COUNT = 000000



The newly entered data is re-displayed for verification or correction if necessary Press the **Y key** to change the data or the **N key** to finish and return to the **STOPPED MODE**.

2 – SHIFT CODE: (OPTION PACK 3 INSTALLED)

1= PRODUCT COUNT
2= SHIFT CODE
3=DATE FORMAT
4=TIME FORMAT

Shift codes may be encoded directly in the printable message. The printer can print 6 individual shift codes. Each shift code contains a unique start time and alpha/numeric code to be printed.

ADJUST SHIFTS
< - - SELECT - - >
SHIFT 1 07:00 A
ANY CHANGES Y/N

Press  or  to change the desired shift to view or change.

The shift code option allows the user to enter 6 different shift times per day. Use the arrow keys to select a shift and enter a Y to change a shifts start time.

All times are in Military Time 00:00 to 23:59 hours.

ADJUST SHIFTS
SHIFT 1
START TIME
ENTER HOURS -

ADJUST SHIFTS
SHIFT 1
START TIME
ENTER HOURS -

Enter the correct start time HOURS for the shift selected.

ADJUST SHIFTS
SHIFT 1
START TIME
ENTER MINUTES -

Enter the correct start time MINUTES for the shift selected.

ADJUST SHIFTS
SHIFT 1

PRINT CODE -

Finally, enter the desired code to be printed in the message. Legal characters are the letters A to Z and the numbers 0 to 9.

ADJUST SHIFTS
< - - SELECT - - >
SHIFT 1 07:00 A
ANY CHANGES Y/N

The printer re-displays the data for the selected shift for verification.

NOTE: THIS PROCEDURE MAY BE REPEATED FOR ALL DESIRED SHIFTS

NOTE: TO DISABLE A SHIFT ENTER A SPACE CHARACTER IN THE PRINT CODE FIELD. THE SHIFT TIMES WILL BE DISPLAYED AS --:-- FOR ALL DISABLED SHIFT TIMES.

3 – DATE FORMAT:

1= PRODUCT COUNT
2= SHIFT CODE
3=DATE FORMAT
4=TIME FORMAT

CHANGE FORMAT
1=CALENDAR DATE
2=OFFSET DATE

MONTH FORMAT
1=NUMERIC
2=LETTERS

DATE FORMAT
D=DAY M=MONTH
Y=YEAR J=JULIAN
dm/dd/dy

DATE FORMAT
D=DAY M=MONTH
Y=YEAR J=JULIAN
jjj

DATE FORMAT
D=DAY M=MONTH
Y=YEAR J=JULIAN
jjjyy

Press **F3** to change the date formatting. Each of the following screens prompts the user to enter the desired format for printing.

NOTE: THE USER MAY INDIVIDUALLY CHANGE THE FORMAT OF BOTH THE CALANDER FORMAT AND THE DATE OFFSET FORMAT

NOTE: THE FOLOWING PROCEDURE APPLYS TO BOTH CALANDER AND OFFSET DATE FORMATS.

Selecting the standard numeric format will prompt the user to enter the format of the date in standard number format.

The default as shipped from the factory is dm/dd/dy, and may be modified as required. If the offset format was selected the word **DATE** is replaced with the word **OFFSET**.

To change the format press the delete key and the last line on the display will be erased. The entire format will be erased and must be re-entered. Press either of the designator keys (i.e. M for month) and the display will display the correct code for the item selected. As an example enter the Julian date and year. Press the J key followed by the Y key. The code entered will print the Julian date followed by the 2-digit year. Notice no delimiters were selected, but may have been entered by selecting the appropriate key on the keyboard. Legal delimiters are the colon (:), the forward slash (/) or the full stop (.).

MONTH FORMAT
1=NUMERIC
2=LETTERS

Alpha characters may have been selected by pressing option 2.

DATE FORMAT
D=DAY M=MONTH
Y=YEAR
jjyy

Delete the current formatting by pressing the Delete key.

DATE FORMAT
D=DAY M=MONTH
Y=YEAR
ddmmyy

Enter the desired Date Format and notice when the M (month) is selected the display shows mmm. Select the appropriate key on the keyboard by entering in the desired code. Press the Enter key to return to the STOPPED mode.

WEEKLY DATE
1=ENABLE
2=DISABLE

The software performs a special function allowing the user to set the current date to change only at a certain day of the week. This function is typically used in batch processing, where a batch may be prepared on Sunday and packaged from Monday to Friday of the following week.

Entering either the current date or offset date in a message will result in the initial date being printed for either function throughout the following week. Selecting option 2 returns the user to the STOPPED mode.

4 – TIME FORMAT:

1= NOT AVAILABLE
2= NOT AVAILABLE
3=DATE FORMAT
4=TIME FORMAT

Change the Time Format by selecting option 4.

NOTE: Delimiter characters like a : code may be entered to separate fields

TIME FORMAT
H=HOURS
M=MINUTES
hh:mm

The factory default for time formatting is hh:mm and may be changed as required. Press the Delete key and the last line on the display is erased.

TIME FORMAT
H=HOURS
M=MINUTES
hh

Enter the desired format by pressing the H and or M keys, and select delimiters as required. Select H if only hours are required.
Press the Enter key to return to the STOPPED mode.

F4 MENU

1 = LANGUAGE
2 = INK SUPPLY
3 = SET UNIT I.D.
4 = LOAD CARD

Place the unit in the Command mode and press **F4**. The screen shown at left is produced. Press the number that corresponds to the parameter you wish to change.

1 - LANGUAGE:

< - - SELECT - - >
ENGLISH

Press **1** and the screen will change like the one on the left. The default language is English; the other choice is Spanish. Scroll through the choices using either **◀** or **▶**. Once the desired language is shown on the screen, press **↵**. This will return the unit to the Command mode. Whenever language is

chosen, all prompts and commands shown on the screen will be in that language.

2 - INK SUPPLY:

REMAINING INK
100
C NEW CARTRIDGE
ANY KEY TO EXIT

The second line of the display shows the percentage of ink remaining in the print cartridge.

Each time a new cartridge is installed the user must reset the system ink gauge by pressing the **C** key.

When a **C** is entered the system automatically profiles the operating conditions for the new cartridge.

Each cartridge is tested and profiled at the factory eliminating the burden of personalising each cartridge by the user. There are a number of tasks associated with print cartridge profiling, as each print cartridge differs from another. The correct drive voltage, pulse width timing and pre-fire pulse warming must be calculated for optimum operation.

NOTE: USING NON-AUTHORISED CARTRIDGES MAY PRODUCE UNDESIRABLE RESULTS

3 – SET UNIT I.D.:

< -- SELECT -- >
SET HEAD # = 1

Each print carriage can contain a unique address to distinguish multiple carriages when controlled by a single hand held controller or computer data link using an RS485 data link. The default for each new print carriage module is ADDRESS 1. Addresses can range from 1 to 32. It is advisable when adding

multiple print carriages to affix a label indicating the unique ADDRESS number of the individual carriage.

Note: To program a carriage it must be connected directly to the hand held controller, with no other carriages connected.

**4 – LOAD CARD:
LOADING FONTS (MENU SELECT 1)**

<p>EXECUTE LOADER 1=LOAD FONTS 2=LOAD LOGOS 3=LOAD OPTIONS</p>	<p>The user can replace the existing FONT, add up to six logos, or load optional software from a Data Flash card, which is plugged into the top of the print carriage. Select 1 to load a different font to replace the current system font.</p>
<p>LOAD FONT 1= LOAD DEFAULTS 2= LOAD ALTERNATE</p>	<p>The screen to the left will appear and after a few seconds a result will be displayed to indicate NOTHING LOADED or the name of the newly loaded font, logos or software upgrades.</p>
<p>LOAD RESULTS PLEASE WAIT</p>	<p>To load or replace the current LOGOS in the system press the 2 key. Similar to loading FONTS the screen at the left will appear indicating the load results.</p>
<p>MEMORY ERROR NO FLASH CARD ANY KEY TO EXIT</p>	<p>This screen will be displayed if the data flash card is either not present or cannot be read. CHECK THAT THE DATA FLASH CARD IS PROPERLY INSTALLED</p>
<p>LOAD RESULTS 2 LINE fontname 1 LINE fontname ANY KEY TO EXIT</p>	<p>A successful load will display the current font names loaded into the print head. This screen will be displayed when the default fonts are loaded.</p>
<p>LOAD RESULTS 2 AF fontname 1 AF fontname ANY KEY TO EXIT</p>	<p>When loading alternate fonts the AF will replace LINE for the alternate font or fonts loaded.</p>

NOTE: when optional fonts are loaded into the system the Data Flash Card is encoded with the serial number of the unit and is valid only for the unit in which the fonts were loaded.

LOADING LOGOS (MENU SELECT 2)

EXECUTE LOADER
1=LOAD FONTS
2=LOAD LOGOS
3=LOAD OPTIONS

The user can replace the existing FONT, add up to six logos, or load optional software from a Data Flash card, which is plugged into the top of the print carriage. Select **2** to load logos into the print head.

EXECUTE LOADER
PLEASE WAIT

MEMORY ERROR
NO FLASH CARD

ANY KEY TO EXIT

This screen will be displayed if the data flash card is either not present or cannot be read.
CHECK THAT THE DATA FLASH CARD IS PROPERLY INSTALLED

LOAD RESULTS
2 LINE 1 2 3
1 LINE 1 2 3
ANY KEY TO EXIT

Displaying the number of logos as indicated in the pictorial indicates successful loading.
 The display indicates the number of logos loaded for the 1 line or 2 line mode.

LOADING OPTIONS (MENU SELECT 3)

EXECUTE LOADER
1=LOAD FONTS
2=LOAD LOGOS
3=LOAD OPTIONS

Optional software may be added via Data Flash Card to the basic unit to add features.

NOTE: when optional software is loaded into the system the Data Flash Card is encoded with the serial number of the unit and is valid only for the unit in which the software was loaded.

CONTROLLER 7.08
PRINTER 2.08I ++++
PRINTER SN284955
ANY KEY TO EXIT

Verify system information by pressing the V key on the hand held controller keyboard. The LCD screen will display the software, firmware, serial number and options enabled. Enabled options are indicated on the second line as a series of + characters where the first + indicates option pack 1, the second + indicates option pack 1.5 the third is option pack 2 and the last + indicates option pack 3.

NOTE: THE FIGURE BELOW SHOWS THE CORRECT ORIENTATION FOR INSERTING THE DATA FLASH CARD.

INSERT THE DATA FLASH CARD INTO THE SLOT PROVIDED AT THE TOP OF THE PRINT CARRIAGE AS SHOWN. NOTE THE ORIENTATION OF THE LABEL ON THE CARD. PRESS THE CARD COMPLETELY INTO THE SLOT. THE CARD SHOULD BE REMOVED AFTER USE AND STORED IN A SAFE PLACE. ONCE LOADED (FONTS & OPTIONS) THE CARD IS SECURITY LOCKED WITH THE SERIAL NUMBER OF THE PRINTER CARRIAGE AND WILL NOT OPERATE IN ANOTHER PRINT CARRIAGE.

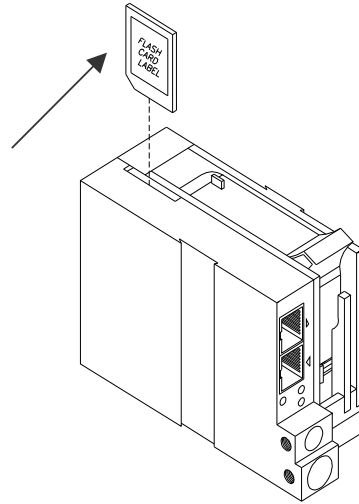

NOTE:

There are two fonts loaded into the CleanCode printer at any one time. Loading a new font will overwrite the existing font or fonts. Print starts at the bottom nozzle of the print head (dot 150 for line 2) and at the middle of the print head (dot 75 line 1). The printer is shipped with a 12.7mm font, a 5.5mm font, a 3.2mm font and a 2.4mm font. The 12.7mm font may be replaced with other than a 12.7mm tall character. Alternate fonts that are loaded replace the existing fonts. Inserting a data flash card containing alternate fonts and cycling the power will temporarily use the alternate fonts on the data flash card until the card is removed and either the power is cycled or the print station is set to the STOPPED mode. This eliminates the need to load the alternate font using the LOAD CARD option.

SETTING PRINT DELAY AND LINE SPEED

LINE SPEED – This setting adjusts the width of the printer message on the product. This setting should be adjusted to produce the desired print on the product. Line speed can be increased or decreased to stretch or compress the message to fit the desired print area.

PRINT DELAY – This setting adjusts the location of the printed message on the product.

STOPPED
HD1- ->SPEED=120
EVOLUTION 1

Access to these parameters is possible when the unit is in either the STOPPED or PRINTING mode as shown to the left.



PRINTING
HD1- ->SPEED=120
EVOLUTION 1

Pressing the  delay key allows the user to determine the amount of print delay. Each count at a normal aspect ratio is approximately 1.5mm. This will vary according the amount of compression or expansion used.



SETTING LINE SPEED

< - - **SELECT** - - >
LINE SPEED = 100

Normally, the system will be set to use the internal time base for line speed control. The default value is 100, which creates a normal width character on a line moving at 100 ft per min. The print can be narrowed by increasing the number and widened by decreasing the number. Pressing  accesses this parameter.

Once pressed, a new screen appears, as shown to the left. Changes can now be made by using  or . The range of values for character width is 1 to 200. Once the desired number is chosen, press  to save your entry.

< - - **SELECT** - - >
ENCODER DIV = 4

If external encoder is enabled and the unit is in the PRINTING mode the user has the option of adjusting the compression ratio of the printer message. Changes may be made by using  or . Once the desired number is chosen, press  to save your entry.

SETTING PRINT DELAY



STOPPED
HD1- - >SPEED=120
EVOLU

Print delay is used to position a message on the product at a location other than at the leading edge. Access this parameter by pressing  on the keypad.

NOTE: This parameter may be set when the unit is either in the PRINTING or STOPPED mode

PRINTING
HD1- - >SPEED=120
EVOLU

< -- SELECT -- >
PRINT DELAY= 100

To change the value use either  or . The range of values for this parameter is 1 to 255. Each increment represents 18 columns, approximately 1.5mm. Therefore, a delay of 255 would approximate 388mm. Once a number is chosen, press  to save the entry.

NOTE: THE DIMENSION INDICATED IS WHILE PRINTING A PERFECT ASPECT RATIO CHARACTER. WHEN PRINTING A COMPRESSED OR EXPANDED CHARACTER THE ACTUAL DIMENSIONAL NUMBER WILL BE DIFFERENT BUT CAN BE ESTIMATED BASED ON THE 18 COLUMNS PER COUNT.

NOTE: Setting the line speed first, then adjusting the print delay may prove to be the best starting point.

INPUT, EDIT OR DELETE MESSAGES

STOPPED
HD1- - >SPEED=120
EVOLU

To input, delete or edit a message, the unit must be in the STOPPED Mode. If the LCD reads PRINTING, press . The screen should be similar to the one shown at the left.



MESSAGE ENTRY
FONT 1 LINE
EVOLU

Enter the Message Entry mode by pressing . The top portion of the screen will change as shown on the left.



MESSAGE ENTRY
FONT 1 LINE

The user has two options to edit or change a message. If a new message is to be entered press the  key to delete the entire existing message.

MESSAGE ENTRY
FONT 1 LINE
DM.DD.DY

For example, to produce  a single line of 1 LINE. Press the font key until  the 1/2 " font size is shown, and enter EXP followed by the  key. This enters the DATE OFFSET as defined in the F1 menu.

MESSAGE ENTRY
FONT 2 LINE
BEST BY
EXP 12/01/2009

To place two lines use the to select 2 LINE size. Press the  key to delete the entire message. Press the  or  to select which line the data will be entered on. Enter BEST BY. The pictorial at the left shows two lines of 2 LINE character size. To enter and print only 1 line of 2 LINE select the line and enter data to that line only.

STOPPED
HD1- - >SPEED=120
BEST BY
EXP 12/01/2009



Once the message line(s) is complete, save the change by pressing .

NOTE: USE THE DATE OFFSET KEY TO ENTER AN EXPIRY DATE.

```

MESSAGE ENTRY
FONT 1 LINE
BEST BY
EXP 12/01/2009

```

The second option is to replace characters by using the  key or moving the cursor over a character to be replaced. When the MESSAGE ENTRY mode is entered the cursor is placed at the end of the line. Pressing the  key will delete the last character on the line. Successive 's will continue to delete the last character on a line. At the left the characters 12/01/2009 were deleted..

```

MESSAGE ENTRY
FONT 1 LINE
BEST BY
EXP

```

```

MESSAGE ENTRY
FONT 1 LINE
BEST BY
EXP 31/12/2009



```

Enter the correct data, in this case 31/12/2009.

```

MESSAGE ENTRY
FONT 1 LINE
BEST BY
EXP 31/12/2014





```

The alternative approach if just a few characters are to change is to use the  or  to place the cursor over the characters to be changed and retype the correct characters. In this example the 31/12/2009 WAS CHANGED TO 31/12/2014.

```

< -- SELECT -- >
!#$&( ) * + = € ■ Ń Ę Ő

```

Symbols are inserted by pressing . When in Message Entry mode, position the cursor where a symbol is needed and press . The screen will show a line of symbols as presented on the left. Position the cursor by pressing  or  on the special character to be inserted and press .

```

EV1 STOPPED
HD1- - >SPEED=120
BEST BY
EXP 12/01/2014

```

Continue to build the message or press  to return to the Command mode.

CleanCode EV I messages may contain up to 2 lines of text. Selecting multiple message lines is accomplished by pressing the font key until the appropriate line designation is displayed.

MESSAGE ENTRY
 - - - - FONT- 1 LINE

Enabling variable field programming requires the use of the special function keys.

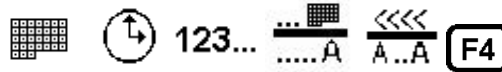

MESSAGE ENTRY
 - - - - FONT- 1 LINE
 DM/DD/DY

To enter a date that automatically changes use the  key. The current date format as set in the F3 menu is entered into the message.

MESSAGE ENTRY
 - - - - FONT- 1 LINE
 HH:MM

To enter a time that automatically changes use the  key. The current date format as set in the F3 menu is entered into the message.

MESSAGE ENTRY
 ##### FONT- 1 LINE
 0000

Sequence numbers may be added to a message with the ^{123...} key. Note when the key is depressed the four ---- are changed to ##### indicating a sequence number field. After entering the correct sequence

MESSAGE ENTRY
 - - - - FONT- 1 LINE
 0000

number press the ^{123...} key to terminate the sequence field. The maximum number of digits allowable is 9 numeric characters.

MESSAGE ENTRY
 < < < < FONT- 1 LINE
 DM.DD.DY

Date offset codes are entered by using the  key. The correct date offset format as defined in the F3

menu is entered into the message with the  key to enter a shift code.

MESSAGE ENTRY
 - - - - FONT- 1 LINE
 S

Shift codes are defined in the F3 menu and will automatically change at the appropriate shift times. The shift designator S is displayed to indicate the data entry.

SEQ. NUMBER
1= COUNT UP
2= COUNT DOWN

Sequence number format is programmable in the STOPPED mode. The counter may be set to count either up or down by selecting number 1 or 2. Pressing enter advances the user to the next menu prompt.

CLEAR SEQ# FIELD

YES OR NO Y/N

Clearing the sequence field resets the counter to their initial settings.

COUNTER LIMIT

ANY CHANGES Y/N
ENTER #000000000

The next prompt allows for changes in the sequence limit field. Selecting Y allows the user to enter the desired maximum (minimum for down count) count. Digits are enter via the keyboard right justified. As an example to set a maximum count of 5000 enter 5000. Pressing the DEL key allows for re-entry while pressing the ENTER key returns the user to the STOPPED mode.

COUNTER LIMIT

ANY CHANGES Y/N
ENTER #000005000

Moving the cursor back over the various characters contained in the message may be used to validate the message. Note that the field designator will normally appear as - - - - indicating an alpha/numeric code as would be seen by moving the cursor under the M F G or the E X P on the second line. The same designator will be seen when the cursor is placed under any non-changeable field including the space character.

Moving the cursor under a variable programmable field will display the correct field designator in place of the - - - - alpha/numeric designator.

<p>MESSAGE ENTRY - - - - FONT- 2 LINE MFG DM/DD/DY HH:MM EXP DM.DD.DY <u>S</u> 0009</p>
--

For example, moving the cursor under the S (shift code) on the second line would display the field designator as < < < <

The various field designators displayed are:

- - - - Alpha/Numeric non-changeable data

Sequence number field

< < < < Shift code field

OM Offset date month field

OD Offset date day field

OY Offset date year field

DM Current date month field

DD Current date day field

DY Current date year field

TH Current time hour field

TM Current time minute field

NOTE: ONLY 15 OBJECTS ARE PERMITTED ON A PARTICULAR LINE. IN THE ABOVE EXAMPLE THE FIRST LINE OF DATA MFG DM/DD/DY HH:MM CONTAINS 10 OBJECT FIELDS. FOR PURPOSES OF CLARITY THE SPACE CHARACTER IS SHOWN AS THE UNDERLINE _ CHARACTER WHERE:

MFG_ = ALPHA/NUMERIC FIELD

DM = DATE MONTH FIELD

/ = ALPHA/NUMERIC FIELD

DD = DATE DAY FIELD

/ = ALPHA/NUMERIC FIELD

DY = DATE YEAR FIELD

_ = ALPHA/NUMERIC FIELD

HH = TIME HOURS FIELD

: = ALPHA/NUMERIC FIELD

MM = TIME MINUTES FIELD

The above constitutes 10 object fields. Even though there are 48 characters permitted per line data entry will be inhibited when the 15th object is entered, although the last field, if it is an alphanumeric object, may contain enough characters to meet the 48-character limit.

Barcodes are also an object field and must be considered when entering a message. Thus a barcode with an imbedded sequence number is counted as two objects.

VARIABLE FIELD FORMAT PRINTING (OPTION PACK 2 OR 3 INSTALLED)

The CleanCode EV I printer provides the operator the capability of adding variable fields to a message. This includes TIME, DATE, SEQUENCE, DATE OFFSET and SHIFT CODE PRODUCT COUNT and BARCODES. Entering any of these special

fields is accomplished with the   123...  A  A..A  keys.

To input, delete or edit a message, the unit must be in the STOPPED Mode. If the LCD reads PRINTING, press . The screen should be similar to the one shown at the left.

MESSAGE ENTRY
FONT 1 LINE

EVOLUTION I

Enter the Message Entry mode by pressing . The top portion of the screen will change as shown on the left.

MESSAGE ENTRY
FONT 1 LINE

The user has two options to edit or change a message. If a new message is to be entered press the  key to delete the entire existing message.

The following applies to either a 1, 2, 3 OR 4 line message.

MESSAGE ENTRY
FONT 1 LINE

MM/DD/DY

To enter a DATE CODE depress the  key. The currently formatted date code as preset under the F3 menu, is inserted into the message.

Note: the current format is displayed as mm for month, dd for day and yy for year

MESSAGE ENTRY
FONT 1 LINE

HH:MM

To enter a TIME CODE depress the  key. The currently formatted time as preset under the F3 menu, is inserted into the message.

Note: the current format is displayed as hh for hours, and mm for minutes

MESSAGE ENTRY
####FONT 1 LINE

0000







To enter a SEQUENCE NUMBER depress the 123... key. Enter the correct number of digits required

the depress the 123... again to end the sequence number field . Note during this operation the #### displayed next to the FONT 1 LINE indicating a

sequence number field. Press the  key to end MESSAGE EDIT and return to the STOPPED MODE.

STOPPED
HD1- - >SPEED=120

DD/DM/

<p>MESSAGE ENTRY FONT 1 LINE</p> <p>EVOLU</p>	<p>Enter the Message Entry mode by pressing . The top portion of the screen will change as shown on the left.</p>
<p>MESSAGE ENTRY FONT 1 LINE</p>	<p>The user has two options to edit or change a message. If a new message is to be entered press the  key to delete the entire existing message.</p>
<p>MESSAGE ENTRY FONT 1 LINE</p> <p>DD.DY</p>	<p>To enter a DATE OFFSET CODE depress the  key. The currently formatted date offset code as preset under the F3 menu, is inserted into the message. The correct number of days to offset are set under the F1 menu.</p>
<p>MESSAGE ENTRY FONT 1 LINE</p> <p>mm.dd.yys</p>	<p>Entering a SHIFT CODE is accomplished by pressing the  key. Shift codes are set under the F3 key. The correct alpha/numeric character preset is added to the message</p>
<p>STOPPED HD1- - >SPEED=120</p> <p>mm.dd.yys</p>	<p>Press the  key to end MESSAGE EDIT and return to the STOPPED MODE. NOTE: Variable field data can be entered anywhere within the message and will be automatically updated at the beginning of each new print cycle</p>
<p>MESSAGE ENTRY FONT 1 LINE</p> <p>mm.mm.yys</p>	<p>Adding a special character or LOGO is accomplished by pressing the S1 or S2 keys and selecting the appropriate special symbol or stored logo.</p>
<p>MESSAGE ENTRY FONT 1 LINE</p> <p>mm.mm.yys#L'</p>	<p>Press the S1 key and position the cursor just prior to the desired character and press the  key. In this case the # character was selected. To add a stored LOGO press the S2 key and scroll through the list of stored logos and press the  key. The logos are displayed by the L</p>

character. Each logo will have an L and 1,2 or 3 embedded ' to indicate the logo selected.

PASSWORD PROTECTION (OPTION PACK 1,1.5,2,3)

PASSWORD XXXXX

With any of the Option Packs installed the CleanCode EV 1 contains a password function designed to limit access to the edit menu and prevent unauthorised changing of message lines. To activate this function, switch the unit off, then press and hold **P** while switching the unit on. The display changes and requests the default password (which is 12345). Enter the 12345.

**ENABLE
PASSWORD
YES OR NO Y/N**

The screen to the left appears and prompts the operator or ENABLE PASSWORD
A response of N maintains the current password and disables password protection.







PASSWORD XXXXX

If the response Y is selected the screen at the left appears to prompt the user to enter a new password. Enter the new 5 character password any combination of letters and numbers may be used. Once this has been completed, the unit will not allow message editing without the entry of the password.

NOTE: If the new password is misplaced or forgotten, reset the unit.

MESSAGE STORAGE (OPTION PACK 1, 1.5 OR 2)





STORING A MESSAGE

<p>MESSAGE # 1</p>	<p>All CleanCode EV 1 printers are able to store up to 50 system wide programmed messages and their associated parameters. Follow these steps to store a message. Create the message and press . Press . Using  or , scroll to the desired message location number.</p>
<p>MESSAGE # 1 PLEASE WAIT</p>	<p>Press  a second time. This places the message into that numeric location for recall at a later time. Use the same procedure to overwrite an existing stored message as well.</p>
<p>MESSAGE # 1 MESSAGE STORED</p> <p>CLEANCODE EV 1</p>	<p>The LCD display will indicate that the message is stored.</p> <p>Press  to exit.</p>

NOTE: Message storage should be used after the product has been coded satisfactorily. When a message is stored all operating parameters of the printed code are saved. Once recalled, codes will be printed the same as they had been before.

Option pack 1 enables the user to store up to 50 messages in the hand held controller. With option pack 1.5 or 2 the controller is capable of storing up to 99 messages.

RECALLING A STORED MESSAGE

<p>MESSAGE # 1</p> <p>CLEANCODE EV 1</p>	<p>Place the unit in "Stopped" mode and press . Use the  or  to scroll through the stored messages. Find the desired message and press .</p>
<p>STOPPED HD1- - >SPEED=120</p> <p>CLEANCODE EV 1</p>	<p>That message is now displayed on the screen ready for printing.</p>

PART 3: MAINTENANCE PROCEDURES

PERIODS OF SHUT DOWN

SHORT PERIODS OF SHUT DOWN

When the printer has been shut down overnight, the system might require a purge to clear out dust particles that have settled on the nozzle area during non-use. This is only necessary if there are missing dots in the printed code on product.

STOPPED
HD1- - >SPEED=120
CLEANCODE EV 1

To purge be sure that the unit is in the STOPPED Mode by pressing green  key. The screen changes to STOPPED as shown to left.

PURGING
HD1- - >SPEED=120
CLEANCODE EV 1

Place a piece of lint free wipe (or absorbant paper) in front of the print head and press the red . Allow the unit to purge for several seconds. There is an automatic shut down after 1,000 printed columns to ensure that the print head will not be damaged. If ink residue has solidified on the nozzle area a small drop of water may be applied to the lint free wipe.

STOPPED
HD1- - >SPEED=120
CLEANCODE EV 1

When purging is complete the LCD will be returned to the STOPPED mode.

PRINTING
HD1- - >SPEED=120
CLEANCODE EV 1

Press the green  and the screen changes to PRINTING, as shown at the left. The unit is ready to begin coding.

LONG PERIODS OF SHUT-DOWN

When the printer is to be shut down for extended periods, or the ink cartridge needs to be changed to insert a different colour cartridge, the ink cartridge should be removed.

Clean the print head nozzle area with a soft, lint free wipes and insure there is no ink residue remaining on the nozzle area. Re-apply the sealing tape. The print cartridge may be stored in a sealable plastic bag.

CAUTION: USE THE ORIGINAL SEALING TAPE SUPPLIED WITH THE CLEANCODE EV 1 INK CARTRIDGE. DO NOT USE ANY OTHER MATERIAL OR ANY ADHESIVE BACKED PRODUCT, AS THIS WILL DAMAGE THE NOZZLE AREA.

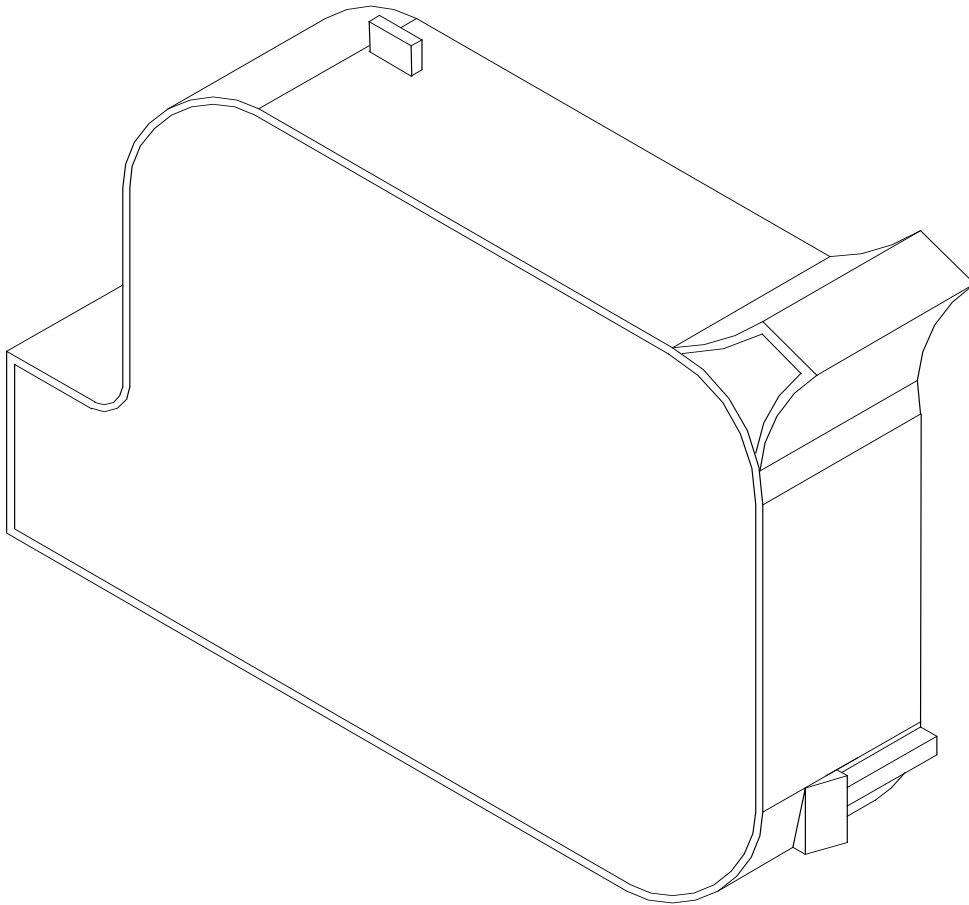

PRINT CARTRIDGE MAINTENANCE

It is necessary to keep the CleanCode EV 1 print cartridge free from accumulated dust and debris. Periodically the cartridge should be removed and cleaned. This is totally dependent on the operating environment and the average printable life of the ink cartridge. In extremely dusty environments, this maintenance procedure may be required regularly.

To clean the cartridge, carefully clean the face of the cartridge with a soft, lint free wipe. Use caution in wiping the NOZZLE area so as not to scratch the face. Always wipe in the ARRAY PLATE vertically as indicated. Clean the CONTACT area in a similar fashion.

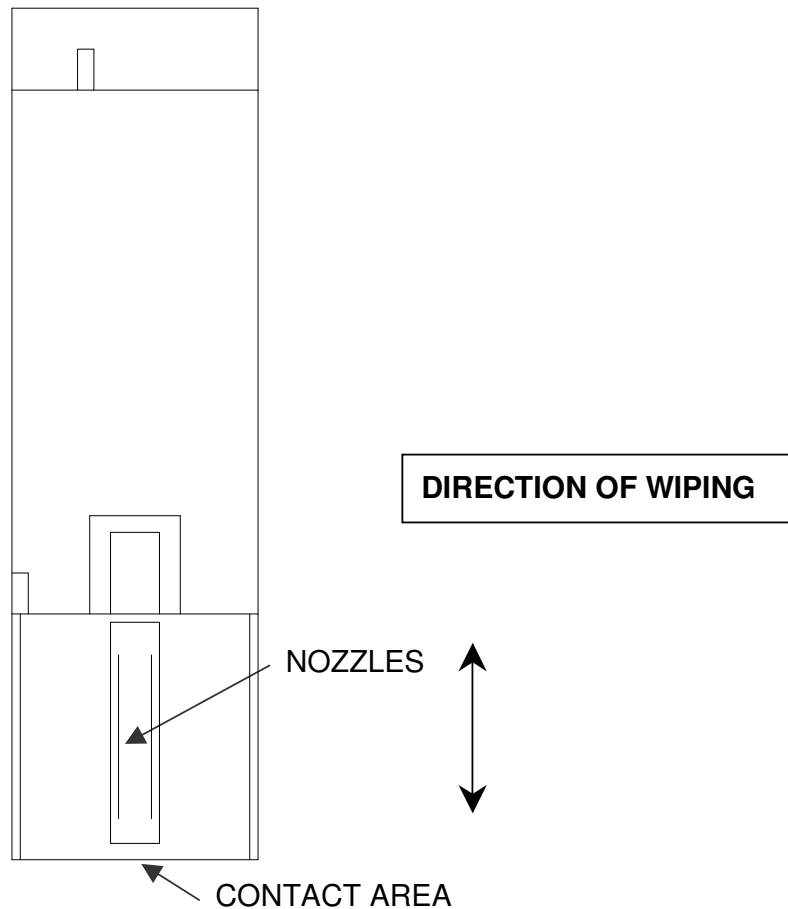

NOTE:

Ingested air or severe nozzle clogs may be eliminated with the use of the cleaning syringe/tray ordered optionally.

The photo below shows the correct procedure in using the syringe and cleaning tray. Insert the ink cartridge into the tray and securely snap into place. Place the tip of the syringe into the front of the tray. While holding the syringe securely in place gently draw back on the syringe plunger until ink flows into the syringe. Normally, it is not necessary to evacuate more than 0.1 cc of ink at a time as indicated below. Following ink withdrawal remove the syringe carefully. Remove the ink cartridge from the tray. Remove any remaining ink from the nozzle face with a lint free wipe. Place a piece of clean white paper directly in front of the print head and perform a purge function by pressing and releasing the purge key . The key is activated on the release of the key. Swipe the paper quickly past the print head to expand the purge pattern so the individual droplets may be viewed. Perform a test print and verify that all nozzles are firing correctly.

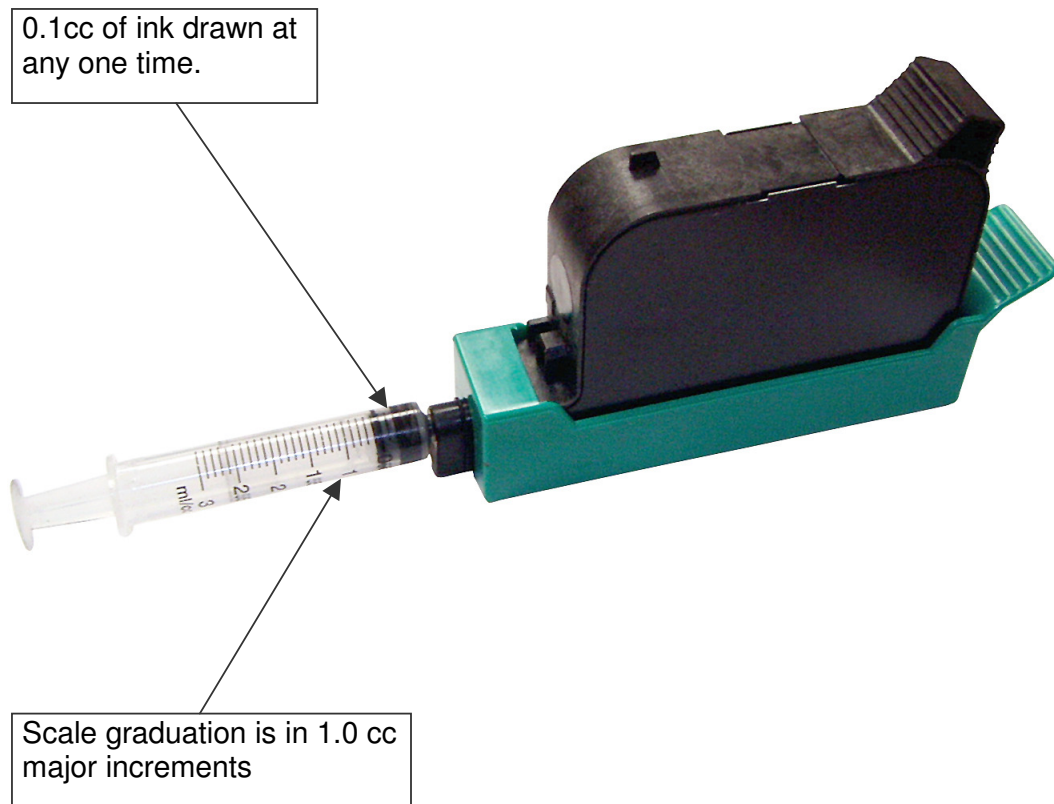

PRINT CARRIAGE MAINTENANCE

It is necessary to keep the print head carriage free from accumulated dust and debris. Periodically the print head carriage should be inspected and cleaned. This is totally dependent on the operating environment. In extremely dusty environments, this maintenance procedure may be required occasionally but on average every week should be sufficient.

Remove the print cartridge and carefully inspect the print carriage for dust and debris.

Re-insert the print cartridge and place the unit into the PRINTING mode by pressing





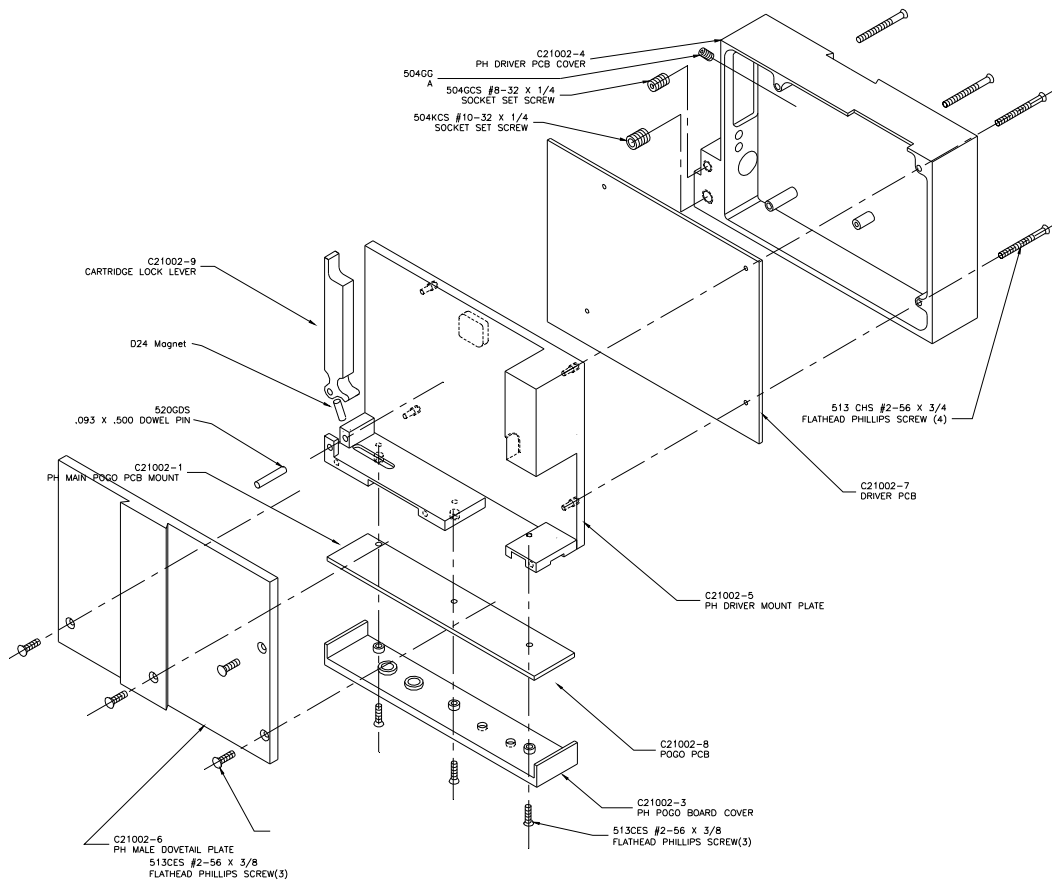



EXPLODED VIEW OF THE PRINT CARRIAGE



PART 4: TROUBLESHOOTING AND REPAIRS

FAULTS

This chart was created to assist the user in troubleshooting the unit. Find the problem in the first column; apply the remedy(s) suggested in the third column.

Condition	Probable Cause	Remedy
LCD remains blank.	No power.	Ensure the controller is securely connected to the correct port on the print carriage assembly
Unit does not print, although LCD shows information.	No message in unit	Input your message (see page 37)
	Unit in "COMMAND" mode.	Press  .
	No ink.	Replace ink cartridge; reset ink volume parameter (press  and follow the sequence.
Low ink indicator on with full ink cartridge.	Did not reset ink volume parameter.	Press  . Continue key entry following menu prompts.
Unit does not purge.	Out of ink.	Replace with full ink cartridge. Reset ink volume parameter (press  .
	Unit in "PRINTING" mode	Press Stop Print.  .
	Ink cartridge clogged	Clean Ink Cartridge Nozzle area with lint free wipe
Missing one or more dots from code.	No ink.	Clean or Replace cartridge and purge system (press  .
	Long down-time.	Follow daily start-up procedure if your line experienced a long down time.
Unit loses data while printing	Static electricity	Eliminate source of static. Attach ground strap between print head and low impedance earth ground.
	High levels of radio frequency.	Move unit to an alternate location or attach ground strap as above.
	Spikes in electrical line.	Use AC line filter

PART 5: PARTS LIST AND OPTIONS

Part No.	Description
	SPARE PARTS
ENC320503	CleanCode EV 1 Controller Cabinet
DIS320504	CleanCode EV 1 Controller LCD Assembly
PCB320507	CleanCode EV 1 Controller PCB Assembly
KEY320506	CleanCode EV 1 Controller Keypad
PRI320511	CleanCode EV 1 Print Head Carriage Assembly
PCB320513	CleanCode EV 1 Print Head Carriage CPU Assembly
PCB320514	CleanCode EV 1 Print Head Carriage POGO Assembly
MOU320106	CleanCode EV 1 Mounting Bracket Assembly
POW320515	CleanCode EV 1 Power supply
	OPTIONS
STA320103	Floor stand
MOU320104	Top Coding Mounting Bracket
SEN320102	External Product Detect
ENC320101	External Encoder
BOX320107	Optional Junction Box
SOF320302	Option Pack 1 Password, Message Store, Auto Repeat
SOF320303	Option Pack 1.5 Expanded Message Length
SOF320304	Option Pack 2 (Option Pack 1 & 1.5) & Time, Date, Consecutive Number
SOF320305	Option Pack 3 (Option Pack 2) & Date Offset, Shift Code, Product Count
FON320341	Alternate Font (Specify when ordering)
LOG320351	Logo Option (Specify when ordering)
	CABLES
CAB320141	CLEANCODE EV RJ50 Cable 150mm
CAB320142	CLEANCODE EV RJ50 Cable 900mm
CAB320143	CLEANCODE EV RJ50 Cable 3m
CAB320144	CLEANCODE EV RJ50 Cable 7.5m
CAB320145	CLEANCODE EV RJ50 Cable 15m
CAB320146	CLEANCODE EV RJ50 Cable 30m
	INKS
INK320201	6 Pack of Black Ink Cartridges for Porous Substrates
INK320202	6 Pack of Red Ink Cartridges for Porous Substrates
INK320203	6 Pack of Green Ink Cartridges for Porous Substrates
INK320204	6 Pack of Blue Ink Cartridges for Porous Substrates
INK320205	6 Pack of Yellow Ink Cartridges for Porous Substrates
	6 Pack of Cyan Ink Cartridges for Porous Substrates
	6 Pack of Ultra Violet Ink Cartridges for Porous Substrates
INK320221	Single Black Ink Cartridge for Semi-Porous Substrates
INK320222	Single Red Ink Cartridge for Semi-Porous Substrates
INK320223	Single Blue Ink Cartridge for Semi-Porous Substrates
INK320231	Single Black Ink Cartridge for Non-Porous Substrates

PART 6: COMMUNICATIONS PROTOCOL

This communication protocol covers all CleanCode EV products. Some commands are not applicable to certain units, and care must be taken in determining what valid commands are for a specific unit. Commands that reference specific units are so noted.

ASCII CHARACTER CHART

	0	1	2	3	4	5	6	7	8	9	A	B	C	D	E	F
0	NUL	SOH	STX	ETX	EOT	ENQ	ACK	BEL	BS	HT	LF	VT	FF	CR	SO	SI
1	DLE	DC1	DC2	DC3	DC4	NAK	SYN	ETB	CAN	EM	SUB	ESC	FS	GS	RS	US
2	SP	!	"	#	\$	%	&	'	()	*	+	,	-	.	/
3	0	1	2	3	4	5	6	7	8	9	:	;	<	=	>	?
4	@	A	B	C	D	E	F	G	H	I	J	K	L	M	N	O
5	P	Q	R	S	T	U	V	W	X	Y	Z	[\]	^	_
6	`	a	b	c	d	e	f	g	h	i	j	k	l	m	n	o
7	p	q	r	s	t	u	v	w	x	y	z	{		}	~	DEL

DESCRIPTION

This communication protocol is based on Version 1.4, which was released NOV 2005 and is used with all CleanCode EV products. The communications option converses with a host computer via an RS485 data link.

NOTE: EACH REQUEST OR COMMAND SENT TO A PRINT STATION RECEIVES A RESPONSE FROM THAT PRINT STATION. COMMUNICATIONS SOFTWARE MUST WAIT FOR A RESPONSE TO DETERMINE IF THE PRINT STATION WAS READY TO ACCEPT THE COMMAND, AND THE DATA WAS VALID AND PROCESSED. NO RESPONSE COULD INDICATE THE DATA WAS LOST. IF AN ERROR WAS DETECTED IN PROCESSING A NAK WITH AN ERROR CODE IS RETURNED.

DATA WORD DEFINITION

Full Duplex
7 Data Bits
1 Even Parity Bit
1 Start Bit
1 Stop Bit

BAUD RATE

115,200 Bits per second

DEFINITIONS

Q=QUERY TO HEAD
R=RESPONSE FROM HEAD
D=DATA UPDATE TO HEAD
X=ACK FROM HEAD
'!'=ASCII CHARACTER OR CHARACTERS
0x21 HEX DATA EQUIVELENT
ADDRESS= TWO ASCII REPRESENTATIONS OF HEX CHARACTERS
'x'|'y' TWO ASCII CHARACTERS REPRESENTING THE UPPER AND LOWER NIBBLE OF A HEXADECIMAL BYTE WHERE X IS THE UPPER NIBBLE AND Y IS THE LOWER NIBBLE
FOR EXAMPLE:
TO SEND A SPEED OF 165 FEET PER MINUTE SEND – ASCII 1 AND ASCII 5
WHICH WOULD BE 0x3A AND 0x35 HEXADECIMAL
TO SEND A DELAY OF 30 SEND – ASCII 3 AND ASCII 0
WHICH WOULD BE 0x33 AND 0x30 HEXADECIMAL

CABLING FOR EVLINK ENVIRONMENT

CON320111 RS232C to RS485 converter module
CAB320110 Cable from PC to RS485 converter module
CAB320xxx Cable (define length) from CleanCode EV units to RS485 data link
PLU320109 Termination plug for RS485 data link

HARDWARE INTERFACE

When connecting multiple print carriages via an RS485 link, input and output connectors are provided on the print station, which allows the cabling to be daisy chained. NOTE: It is important to remember to set each of the print stations to a unique address.

PHYSICAL CONNECTIONS RS485 PRINT CARRIAGE

Pin # 4	= Receive +
Pin # 5	= Receive -
Pin # 6	= Transmit +
Pin # 7	= Transmit -
Pin # 9	= Ground

Note: At the end of the data link a termination plug is installed to balance the RS485 data link-connecting pin 4 to pin 5 and pin 6 to pin 7 with 120-ohm.

PROTOCOL FORMAT

Host request for information;

ESC|Command|SOH|EOT (Single End Host to 1 printer)

Or

ESC|STX|Address|Command|SOH|EOT (Multiple printers)

Host sending new information;

ESC|Command|Data|EOT (Single End Host to 1 printer)

Or

ESC|STX|Address|Command|Data|EOT (Multiple printers)

CLEANCODE EV PRINTABLE CHARACTER SET

A B C D E F G H I J K L M N O P Q R S T U V W X Y Z

0 1 2 3 4 5 6 7 8 9

Special Symbols:

<u>ASCII Character</u>	<u>Hexadecimal</u>	<u>Prints As</u>
Space	(0x20)	Space
!	(0x21)	Hour Glass
#	(0x23)	#
\$	(0x24)	\$
&	(0x26)	&
((0x28)	(
)	(0x29))
*	(0x2a)	*
+	(0x2b)	+
-	(0x2d)	-
.	(0x2e)	Period
=	(0x3d)	=
:	(0x3a)	:
/	(0x2f)	/
"	(0x22)	Cents
%	(0x25)	Solid block
;	(0x3b)	Ñ
?	(0x3f)	Ë
@	(0x40)	Ó
{	(0x7b)	Logo 1
	(0x7c)	Logo 2
}	(0x7d)	Logo 3

SOFTWARE PROTOCOL

In the following pages, all references to characters or digits pertain to the standard ASCII character set. The bar (|) character is used as a field separator and it is not part of the transferred data. When data is shown in hexadecimal, it will consist of the hex number preceded by a 0x, for example (0x1B). Generally, all packets to and from a print station begin with an ESC (0x1B) and terminate with an EOT (0x04).

There are two types of commands:

Downloading information to the print station

Requesting information from the print station.

To distinguish the two types of commands, a SOH (0x01) is placed after the command byte in a request command string. The following illustrates this concept:

To download data to print station

ESC/GROUP ADDRESS/UNITADDRESS/COMMAND/DATA/EOT

To request data from the Print Station

ESC/GROUP ADDRESS/UNITADDRESS/COMMAND/SOH/EOT

NOTE: EACH REQUEST OR COMMAND SENT TO A PRINT STATION RECEIVES A RESPONSE FROM THAT PRINT STATION. COMMUNICATIONS SOFTWARE MUST WAIT FOR A RESPONSE TO DETERMINE IF THE PRINT STATION WAS READY TO ACCEPT THE COMMAND, AND THE DATA WAS VALID AND PROCESSED. NO RESPONSE COULD INDICATE THE DATA WAS LOST. IF AN ERROR WAS DETECTED IN PROCESSING A NAK WITH AN ERROR CODE IS RETURNED.

ERROR CODES

Commands to a print station, if completed successfully, return a single byte response of an ASCII ACK (0x06). If the command was not successful, a two-byte response of an ASCII NAK (0x15) is returned, followed by an error code.

Below is a list of the returned error codes.

NAK 1	= NOT USED
NAK 2	= Illegal Command Byte
NAK 3	= NOT USED
NAK 4	= NOT USED
NAK 5	= Trying to write a read only register
NAK 6	= Print station buffer full must print before next download to clear buffer.
NAK 7	= NOT USED
NAK 8	= NOT USED

COMMANDS:**'!' 0x21 Software Version (read only)
(EV I, EV II, EV SC)**

Q. ESC|STX|Address|'|SOH|EOT

R. ESC|STX|Address|{PRINTER ffffssss}|CR|EOT

Where:

PRINTER= ASCII string PRINTER for CLEANCODE EV I
 EV2 for CLEANCODE EV II
 EVSC for CLEANCODE EV SC

ffff = Software and Firmware versions

(eg. 2.02H indicates version 2.02 with Firmware version H)

ssss = Optional Software loaded

Where: (for EV I only)

The first y indicates option pack 1

The second y indicates option pack 2

The third y indicates option pack 1.5

The last y is reserved for future expansion

Where: (for EV II and EV SC)

Both units are standard with all options thus a ++++ will be returned

**'#' 0x23 Printer Configuration (Read only)
(EV I, EV II, EV SC)**

Q. ESC|STX|Address|`#`|SOH|EOT

R. ESC|STX|Address|`#`|`x`|`y`|EOT

Where Byte x Bits 3,2,1,0

Bit 3 = if 1 Cartridge Not Valid

Bit 2 = Not Used

Bits 1,0 = System Type

11 = Evolution 1

10 = Evolution 2

01 = Evolution 3

00 = Evolution Small Character

Where Byte y Bits 3,2,1,0

0000 = no options available

0001 = option1 enabled

0010 = option2 enabled

0100 = option3 enabled

**'\` 0x5c Unit Serial Number (Read only 6 digits)
(EV I, EV II, EV SC)**

Q. ESC|STX|Address|`\`|SOH|EOT

R. ESC|STX|Address|`\`|serial number`|CR|EOT

**'I' 0x6c Special Field Flags
(EV II, EV SC AND EVI WITH OP1 AND ABOVE)**

Q. ESC|STX|Address|`I`|SOH|EOT

R. ESC|STX|Address|`I`|`x`|`y`|EOT

Where: x defines bits 7,6,5,4

Bit 7 = don't care

Bit 6 = dont care

Bit 5 = 1 = No guard bars

Bit 4 = 1 = Man read added to barcode

Where: y defines bits 3,2,1,0

Bit 3 = 1 = Bar checksum added to barcode

Bit 2 = 0 = Calendar will only change on 1st day of week

Bit 1 = 1 = Day of the week is alpha

Bit 0 = 1 = counting down

D. ESC|STX|Address|`I`|`x`|`y`|EOT

X. ESC|STX|Address|`I`|ACK|EOT

**'8' 0x38 Control Flags
(EV I, EV II, EV SC)**

Q. ESC|STX|Address|`8`|SOH|EOT

R. ESC|STX|Address|`8`|`x`|`y`|EOT

Where: x defines bits 7,6,5,4

Bit 7 1 = Head busy printing message

Bit 6 1 = Print image inverted

Bit 5 1 = Head busy manual cycle

Bit 4 1 = Head busy purging

Where: y defines bits 3,2,1,0

Bit 3 1 = External Encoder

Bit 2 1 = External Product Detect

Bit 1 1 = Direction forward

Bit 0 1 = Enable print mode

D. ESC|STX|Address|`8`|`x`|`y`|EOT

X. ESC|STX|Address|`8`|ACK|EOT

Where: x defines bits 7,6,5,4

Bit 7 Don't Care

Bit 6 1 = Print image inverted

Bit 5 Don't Care

Bit 4 Don't Care

Where: y defines bits 3,2,1,0

Bit 3 1 = External Encoder

Bit 2 1 = External Product Detect

Bit 1 1 = Direction forward

Bit 0 1 = Enable print mode

'G' 0x47 Errors (note: error codes must be reset)
(EV I, EV II, EV SC)

Q. ESC|STX|Address|`G`|SOH|EOT

R. ESC|STX|Address|`G`|`x`|`y`|EOT

Where: x defines bits 7,6,5,4

Bit 7 = UART Overrun Error

Bit 6 = Communication Overrun Error

Bit 5 = UART Framing Error

Bit 4 = UART Parity Error

Where: y defines bits 3,2,1,0

Bit 3 = Font checksum error loading from card to chip

Bit 2 = Font 1 checksum error in Ram

Bit 1 = Font 0 checksum error in Ram

Bit 0 = Real Time Clock Memory error

TO RESET ERROR CODES

D. ESC|STX|Address|`G`|`x`|`y`|EOT

same bit positions as above

use only as a mask to clear error bits.

i.e. x = 0001 and y = 0001 clears real time clock memory error and UART parity error.

X. ESC|STX|Address|`G`|ACK|EOT

'R' 0x52 Head Status (read only)
(EV I, EV II, EV SC)

Q. ESC|STX|Address|`R`|SOH|EOT

R. ESC|STX|Address|`R`|`x`|`y`|EOT

Where: x defines bits 7,6,5,4

Bit 7 = Not Used

Bit 6 = Latched eye active

Bit 5 = Unfiltered eye active

Bit 4 = Product being printed

Where y defines bits 3,2,1,0

Bit 3 = auto repeat print gap active

Bit 2 = Not Used

Bit 1 = Input buffer Line 2 full

Bit 0 = Input buffer Line 1 full

'B' 0x42 Set Unit Address (Write Only)
(EV I, EV II, EV SC)

D. ESC|STX|Address|`B`|`x`|`y`|EOT

X. ESC|STX|Address|`B`|ACK|EOT

Where x y = 8 bit unit address

i.e. x = 0x31 & y = 0x35 yields unit address 15

'1' 0x31 Auto Repeat Inter-print delay (Range 0 - 255)
(EV II, EV SC AND EVI with any option pack)

Q. ESC|STX|Address|`1`|SOH|EOT
 R. ESC|STX|Address|`1`|`x`|`y`|EOT

D. ESC|STX|Address|`1`|`x`|`y`|EOT
 X. ESC|STX|Address|`1`|ACK|EOT

0 = Auto Repeat Disabled

Each count provides a delay equal to 16 columns for EV I and EV II.
 Each count provides a delay equal to 2 columns for EV SC.

'&' 0x26 Line Speed (RANGE 10-200)
(EV I, EV II, EV SC)

Q. ESC|STX|Address|`&`|SOH|EOT
 R. ESC|STX|Address|`&`|`x`|`y`|EOT

D. ESC|STX|Address|`&`|`x`|`y`|EOT
 X. ESC|STX|Address|`&`|ACK|EOT

'd' 0x64 Encoder Divider (Range 0-7)
(EV I, EV II, EV SC)

Q. ESC|STX|Address|`d`|SOH|EOT
 R. ESC|STX|Address|`d`|`x`|`y`|EOT

D. ESC|STX|Address|`d`|`x`|`y`|EOT
 X. ESC|STX|Address|`d`|ACK|EOT

''' 0x27 Product Delay (RANGE 1-255)
(EV I, EV II, EV SC)

Q. ESC|STX|Address|`0x27`|SOH|EOT
 R. ESC|STX|Address|`0x27`|`x`|`y`|EOT

D. ESC|STX|Address|`0x27`|`x`|`y`|EOT
 X. ESC|STX|Address|`0x27`|ACK|EOT

')' 0x29 Inter-Character spaces (RANGE 1-25)
(EV I, EV II, EV SC)

Q. ESC|STX|Address|`)`|SOH|EOT
 R. ESC|STX|Address|`)`|`x`|`y`|EOT

D. ESC|STX|Address|`)`|`x`|`y`|EOT
 X. ESC|STX|Address|`)`|ACK|EOT

**'>' 0x3E Head Align (Range 0 - 16) 'O' on keyboard
(EV II only)**

- Q. ESC|STX|Address|>|SOH|EOT
 R. ESC|STX|Address|>|x`|y`|EOT
 D. ESC|STX|Address|>|x`|y`|EOT
 X. ESC|STX|Address|>|ACK|EOT

**'4' 0x34 Sequence Number Rollover Value
(EV II, EV SC AND EV1 with version 2.09 and OP2 or 3)**

- Q. ESC|STX|Address|4`|SOH|EOT
 R. ESC|STX|Address|4`|#####|CR|EOT
 where ##### = rollover value in ascii
 D. ESC|STX|Address|4`|#####|CR|EOT
 X. ESC|STX|Address|4`|ACK|EOT

**'[' 0x5b DATE_ROLLOVER
(EV II, EV CS AND EV1 with version 2.09 and OP2 or 3)**

- Q. ESC|STX|Address| [|SOH|EOT
 R. ESC|STX|Address| [|x`|y`|x1`|y1`|EOT
 Where:
 |x`|y`| = Time of Day Hours
 |x1`|y1`| = Time of Day Minutes
 D. ESC|STX|Address| [|x`|y`|x1`|y1`|EOT
 X. ESC|STX|Address| [|ACK|EOT

**'3' 0X31 Days until Expiration (max 999)
(EV II, EV SC AND EVI WITH OP3)**

- Q. ESC|STX|Address|3`|SOH|EOT
 R. ESC|STX|Address|3`|aaaa`|EOT
 Where: each set of 2 ASCII characters represent the upper and
 lower nibble of a packed BCD byte
 D. ESC|STX|Address|3`|aaaa`|EOT
 Where: each set of 2 ASCII characters represent the upper and
 lower nibble of a packed BCD byte
 X. ESC|STX|Address|3`|ACK|EOT

**'r' 0x52 Remaining Ink (0 to 99%)
(EV I, EV II, EV SC)**

- Q. ESC|STX|Address|R`|SOH|EOT
 R. ESC|STX|Address|R`|x`|y`|EOT

**'0' 0x30 Shift Code (max 6 shift codes)
(EV II, EV SC AND EVI WITH OP3)**

Q. ESC|STX|Address|`0`|SOH|EOT

R. ESC|STX|Address|`0`|`hh mm`|{zz}|.....|CR|EOT

Where: each set of 2 ASCII characters represent the upper and lower nibble of a packed BCD byte

..... = pattern repeat for each shift code programmed

hh = shift start hours

mm = shift start minutes

zz = shift code to print

D. ESC|STX|Address|`0`|`hhmm`|{z}|CR|EOT

Where: each set of 2 ASCII characters represent the upper and lower nibble of a packed BCD byte

hh = shift start hours

mm = shift start minutes

zz = shift code to print

X. ESC|STX|Address|`0`|ACK|EOT

**'/' 0x2f Product Counter (6 Digits Max)
(EV II, EV SC AND EVI WITH OP3)**

Q. ESC|STX|Address|`/`|SOH|EOT

R. ESC|STX|Address|`/`|`HH MM hh mm`|{cccccc}|CR|EOT

Where: each set of 2 ASCII characters represent the upper and lower nibble of a packed BCD byte

HH = Product counter start hours

MM = Product counter start minutes

hh = Product counter stop hours

mm = Product counter stop minutes

cccccc = counter (6 Digits Max)

D. ESC|STX|Address|`/`|`ww xx yy zz`|{cccccc}|CR|EOT

Where: each set of 2 ASCII characters represent the upper and lower nibble of a packed BCD byte

HH = Product counter start hours

MM = Product counter start minutes

hh = Product counter stop hours

mm = Product counter stop minutes

cccccc = counter

X. ESC|STX|Address|`/`|ACK|EOT

SPECIAL FIELD OBJECTS

Message Objects define special characteristics about the messages contained in line 1 or line 2. These may define for example font size, sequence number, date code, etc. There may be up to 15 Objects (special fields) for each line in a message with the limitation that there can only be 1 sequence number imbedded in a message.

'P' 0x50 Message Objects (EV I, EV II, EV SC)

Q. ESC|STX|Address|`P`|SOH|aabb|EOT

R. ESC|STX|Address|`P`|'aa bb cc dd ee ff gggg hhhh'|EOT

Where: each set of 2 ASCII characters represent the upper and lower nibble of a byte

aa = objects for which line 0 or 1

bb = number of objects transmitted. (Max 15)

Each object as defined by bb: (repeat the for each object)

cc = Position within message string

dd = Number of characters in object

ee = Attribute of the object

Where:

ee= 00 Normal Alpha/Numeric character

ee= 01 Time Hours

ee= 02 Time Minutes

ee= 03 Time Seconds

ee= 04 Date Month

ee= 05 Date Day

ee= 06 Date Year

ee= 07 Date Julian

ee= 08 Sequence Number (1 per message)

ee= 09 Barcode

ee= 0A Shift Code

ee= 0B Expiration Date Month

ee= 0C Alpha Date Code

ee= 0D Expiration Date Year

ee= 0E Expiration Date Julian

ee= 0F Expiration Date Day

ee= 10 Day of Week (1-7)

ee= 80 Bar Code Attribute (EV II only)

The above constitutes 10 object fields. Even though there are 48 characters permitted per line data entry will be inhibited when the 15th object is entered, although the last field, if it is an alpha/numeric object, may contain enough characters to meet the 48-character limit.

Barcodes are also an object field and must be considered when entering a message. Thus a barcode with an imbedded sequence number is counted as two objects.

'P' 0x50 Message Objects (continued)

ff = font of object

Where: for EV I AND EV II

ff= 00 for 2 Line Font

ff= 01 for 1 Line Font

ff= 02 for 3 Line Font (EV II only)

ff= 03 for 4 Line Font (EV II only)

Where: for EVSC ONLY

ff= 00 for S5 Font

ff= 01 for S7 Font

ff= 02 for B7 Font

ff= 03 for S12 Font

ff= 04 for B12 Font

gggg = starting column of object in printed image (reserved)

hhhh = starting row of object in printed image (reserved)

D. ESC|STX|Address|`P`|aa bb cc dd ee ff gggg hhhh|EOT

X. ESC|STX|Address|`P`|ACK|EOT

NOTE: TO ENTER A LOGO CALLOUT INTO A MESSAGE USE THE ACSII CHARACTERS 0x7B FOR LOGO1 0x7C FOR LOGO 2 AND 0x7D FOR LOGO 3

'\$' 0x24 Line 1 Message**(EV I max 24 characters – 48 characters OP1.5, 2 or 3)****(EV II max 48 characters)****(EV SC max 96 characters)**

Q. ESC|STX|Address|`\$`|SOH|EOT

R. ESC|STX|Address|`\$`|{message}|CR|EOT

D. ESC|STX|Address|`\$`|{message}|CR|EOT

X. ESC|STX|Address|`\$`|ACK|EOT

'%' 0x25 Line 2 Message**(EV I max 24 characters – 48 characters OP1.5, 2 or 3)****(EV II max 48 characters)****(EV SC max 96 characters)**

Q. ESC|STX|Address|`%`|SOH|EOT

R. ESC|STX|Address|`%`|{message}|CR|EOT

D. ESC|STX|Address|`%`|{message}|CR|EOT

X. ESC|STX|Address|`%`|ACK|EOT

**'w' 0x77 Line 3 Message (max 24 characters)
(EV II only max 48 characters)**

- Q. ESC|STX|Address|\$`|SOH|EOT
- R. ESC|STX|Address|\$`|{message}|CR|EOT

- D. ESC|STX|Address|\$`|{message}|CR|EOT
- X. ESC|STX|Address|\$`|ACK|EOT

**'z' 0x7a Line 4 Message (max 24 characters)
(EV II only max 48 characters)**

- Q. ESC|STX|Address|\$`|SOH|EOT
- R. ESC|STX|Address|\$`|{message}|CR|EOT

- D. ESC|STX|Address|\$`|{message}|CR|EOT
- X. ESC|STX|Address|\$`|ACK|EOT

**':' 0x3A Logo1 Name (read only - max 9 characters)
(EV I, EV II)**

- Q. ESC|STX|Address|:`|SOH|`x`|`y`|EOT
- R. ESC|STX|Address|:`|{logo name}|CR|EOT

Where: x = don't care

y = Bit 0 = 0 = Logo Name in Font 0
1 = Logo Name in Font 1

Bit 1 = 0 = Get Name from on board data flash chip
1 = Get Name fro Data Flash card

**';' 0x3B Logo2 Name (read only - max 9 characters)
(EV I, EV II)**

- Q. ESC|STX|Address|`;`|SOH|`x`|`y`|EOT
- R. ESC|STX|Address|`;`|{logo name}|CR|EOT

Where: x = don't care

y = Bit 0 = 0 = Logo Name in Font 0
1 = Logo Name in Font 1

Bit 1 = 0 = Get Name from on board data flash chip
1 = Get Name fro Data Flash card

**'<' 0x3C Logo3 Name (read only - max 9 characters)
(EV I, EV II)**

- Q. ESC|STX|Address|`<`|SOH|`x`|`y`|EOT
- R. ESC|STX|Address|`<`|{logo name}|CR|EOT

Where: x = don't care

y = Bit 0 = 0 = Logo Name in Font 0
1 = Logo Name in Font 1

Bit 1 = 0 = Get Name from on board data flash chip
1 = Get Name fro Data Flash card

**'Q' 0x51 Starting Sequence Number (max. length 9 digits)
(EV II, EV SC AND EV1 with version 2.09 and after)**

Q. ESC|STX|Address|`Q`|SOH|EOT
R. ESC|STX|Address|`Q`|{zzzzzzzzz}|CR|EOT

Where:

zzzzzzzzz = ASCII string which is the starting sequence number to print.

D. ESC|STX|Address|`Q`|{zzzzzzzzz}|CR|EOT
X. ESC|STX|Address|`Q`|ACK|EOT

**'2' 0x32 Date and Time Setting / Reading
(EV I, EV II, EV SC)**

Q. ESC|STX|Address|`2`|SOH|EOT
R. ESC|STX|Address|`2`|`aa bb cc dd ee ff gg`|EOT

Where: each set of 2 ASCII characters represent the upper and lower nibble of a packed BCD byte
aa= Time of Day Seconds (not used)
bb= Time of Day Minutes
cc= Time of Day Hours
dd= Day of Week
ee= Date Day
ff = Date Month
gg= Date Year

D. ESC|STX|Address|`2`|`aa bb cc dd ee ff gg`|CR|EOT
X. ESC|STX|Address|`2`|ACK|EOT

**'u' 0x75 Store message in non-volatile memory (Write only)
(EV I, EV II, and EV SC)**

D. ESC|STX|Address|`u`|EOT
X. ESC|STX|Address|`u`|ACK|EOT

NOTE: THE FOLLOWING CODES ARE SPECIFIC TO CLEANCODE EV II ONLY**' "' 0x22 Minimum Bar Width (Range 3-15 Data matrix 2-15)
Default 5**

Q. ESC|STX|Address|`"|SOH|EOT
 R. ESC|STX|Address|`"|`x`|y`|EOT

D. ESC|STX|Address|`"|`x`|y`|EOT
 X. ESC|STX|Address|`"|ACK|EOT

' .' 0x2e Bleed Compensation (Range 0 - 3) Default 0

Q. ESC|STX|Address|`.|SOH|EOT
 R. ESC|STX|Address|`.|`x`|y`|EOT

D. ESC|STX|Address|`.|`x`|y`|EOT
 X. ESC|STX|Address|`.|ACK|EOT

' * ' 0x28 Quiet Zone (Range 0 - 150) Default 75

Q. ESC|STX|Address|`*|SOH|EOT
 R. ESC|STX|Address|`*|`x`|y`|EOT

D. ESC|STX|Address|`*|`x`|y`|EOT
 X. ESC|STX|Address|`*|ACK|EOT

'n' 0x6e Type of Barcode (read only)

Q. ESC|STX|Address|`n|SOH|EOT
 R. ESC|STX|Address|`n|`x`|y`|EOT

where

x = number of available barcodes

y = type of barcode

0= CODE39

1= TWO OF FIVE

2= CODE 128B

3= CODE 128C

4= UPCA

5= UPCE

6= EAN8

7= EAN13

8= DATAMATRIX

'?' 0x3F Barcode Name(read only)

Q. ESC|STX|Address|`?`|SOH|`x`|`y`|`x1`|`y1`|EOT

Where:

 `x`|`y` = Barcode type as in 'n' command

 `x1`|`y1` = don't care

R. ESC|STX|Address|`?`|{BARCODENAME}|CR|EOT

 where BARCODENAME = Ascii name of type of barcode

'=' 0x3d Barcode Verify

D. ESC|STX|Address|`= `|`x`|`y`|{BARCODESTRING}|CR|EOT

 x = don't care

 y = type of barcode (same as 'n' command)

 BARCODESTRING = Barcode Ascii data

X. ESC|STX|Address|`= `|`xy`|EOT

 where

 if barcode verifies

 ESC|STX|Address|`= `|ACK|EOT

 if barcode doesn't verify

 ESC|STX|Address|`= `|NAK|{9}|EOT

Example written in C to query a print station to determine the line speed.

```

// Query Print Station Address 7 for Line Speed
putchar(0x1b);      // Send out ESC
putchar(0x02);      // Send out STX
putchar(0x30);      // Send out upper nibble of address 07
putchar(0x37);      // Send out lower nibble of address 07
putchar(0x26);      // Send out a '&' command
putchar(0x01);      // Send out SOH
putchar(0x04);      // Send out EOT

// Get results from print station
{
  unsigned char dummy,speed;

  dummy = getchar();      // Get ESC
  dummy = getchar();      // Get STX
  dummy = getchar() << 4; // Get upper nibble of address
  dummy |= getchar() & 0x0f; // Get lower nibble of address
  if(dummy == our_address)
  {
    dummy = getchar();      // Get command
    speed = getchar() << 4; // Get upper nibble of speed
    speed |= getchar() & 0x0f; // Get lower nibble of speed
    dummy = getchar();      // Get EOT
  } else {
    // error handler (not our address)
  }
}

```

Example written in C to send a line speed to a print station

```

// Send Print Head Address 2 Line Speed of 100 feet per minute.
putchar(0x1b);           // Send out ESC
putchar(0x02);           // Send out STX
putchar(0x30);           // Send out upper nibble of address
putchar(0x32);           // Send out lower nibble of address
putchar(0x26);           // Send out '&' command
putchar(0x36);           // Send out upper nibble for Line Speed 100
putchar(0x34);           // Send out lower nibble for Line Speed 100
putchar(0x04);           // Send out EOT

// Get results from print station
{
unsigned char dummy;

    dummy = getchar();           // Get ESC
    dummy = getchar();           // Get STX
    dummy = getchar() << 4;      // Get upper nibble of address
    dummy |= getchar() & 0x0f;   // Get lower nibble of address
    if(dummy == our_address)
    {
        dummy = getchar();       // Get command
        dummy = getchar();       // Get ACK for print station
        if(!dummy == ACK)
        {
            // error handler (didn't get acknowledgement from printer)
        } else {
            dummy = getchar();    // Get EOT
        }
    } else {
        // error handler (not our address)
    }
}

```

Example written in VB to send a new message to a print station.

```

Public Sub DoMessage()
DATA$ = "800": GETINFODATA: Rem DISABLE PRINT MODE
DATA$ = "&32": GETINFODATA: Rem SET LINE SPEED TO 50
DATA$ = "P01010010000100000000" & Chr$(&HD): GETINFODATA: Rem SET OBJECTs
DATA$ = "%ABCDEFGHJIJ" & Chr$(&HD): GETINFODATA: Rem SEND MESSAGE
End Sub

Public Sub GETINFODATA() : : Rem SENDS A COMMAND AND GETS A RESPONSE
RESPONSE$ = "": COMM.InBufferCount = 0
COMM.Output = ESC & STX & "01" & DATA$ & EOT
Timer.Enabled = True: TIMERFLAG = False
GETINFO:
  Do
    DoEvents
    If TIMERFLAG = True Then GoTo TCOMMERROR
  Loop Until COMM.InBufferCount >= 1
  RESPONSE$ = RESPONSE$ & COMM.Input
  If InStr(RESPONSE$, Chr$(&H15)) > 0 Then GoTo GETDATAERROR:
Rem A NAK WAS RECEIVED
  If InStr(RESPONSE$, Chr$(&H4)) = 0 Then GoTo GETINFO
Rem AN EOT WAS RECEIVED
  RESPONSE$ = Mid$(RESPONSE$, 6, Len(RESPONSE$))
Rem DELETE ADDRESS HEADER
  Timer.Enabled = False
Rem WE NOW HAVE A VALID RESPONSE
  Exit Sub
GETDATAERROR:
  Timer.Enabled = False: TIMERFLAG = False
  GoTo PROCESSERROR
  Exit Sub
TCOMMERROR:
  Timer.Enabled = False: TIMERFLAG = False
PROCESSERROR:
If RESPONSE$ = "" Then RESPONSE$ = "0" Else RESPONSE$ = Right$(RESPONSE$, 1): Rem
GET THE ERROR CODE
Select Case (RESPONSE$)
  Case 0
    MSG$ = "NO RESPONSE FROM UNIT"
  Case 1
    MSG$ = "TRANSMISSION ERROR"
  Case 2
    MSG$ = "ILLEGAL COMMAND"
  Case 3
    MSG$ = "TRYING TO PRINT WHILE IN COMMAND MODE"
  Case 4
    MSG$ = "TRYING TO READ A WRITE ONLY REGISTER"
  Case 5
    MSG$ = "TRYING TO WRITE A READ ONLY REGISTER"
  Case 6
    MSG$ = "UNIT INPUT BUFFER FULL"
  Case 7
    MSG$ = "UNIT IN EDIT MODE"
  Case 8
    MSG$ = "PRINT STATION BUSY TRY AGAIN"
End Select
MsgBox MSG$
COMM.InBufferCount = 0: Rem FLUSH THE INPUT BUFFER
End Sub

```

THE ABOVE VB ROUTINES DEMONSTRATE THE ENTIRE SEQUENCE OF:

- **PREPARING DATA TO SEND TO THE HEAD**
- **SENDING THE DATA TO THE HEAD**
- **WAIT FOR A RESPONSE**
- **DETERMINE IF THE DATA WAS ACCEPTED OR REJECTED**

PART 7: OPTION JUMPERS AND CABLING

OPTION JUMPER DESCRIPTIONS

Factory default for all jumper settings is in the ON position. To remove a jumper in the OFF position place the jumper on a single pin for future use

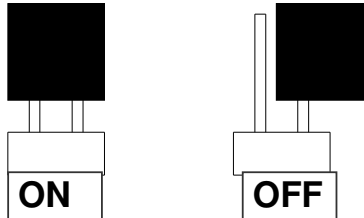

VSEL J7

This jumper when in the ON position supplies a +12vdc source on the RJ50 input connector. The hand held controller uses this source for power. Removing this jumper prevents the +12vdc source from exiting on pin 2 and possibly damaging other external control devices.

ENSEL J9

When this jumper is in the ON position the external encoder signal connected to the RJ50 output connector is passed through the print carriage to the RJ50 input connector. This allows the same encoder signal to drive several print carriages. If this is not desired remove the jumper

PRSEL J10

When this jumper is in the ON position the external product detect signal connected to the RJ50 output connector is passed through the print carriage to the RJ50 input connector. This allows the same product detect signal to drive several print carriages. If this is not desired remove the jumper

OPTION CABLING DESCRIPTIONS

CleanCode EV printers can accept inputs from external sources to control product detection and timing circuits to track product speed (Encoders). These device inputs are internally connected to pull-up resistors and drive optically isolated devices and may be driven by open collector or switch contacts.

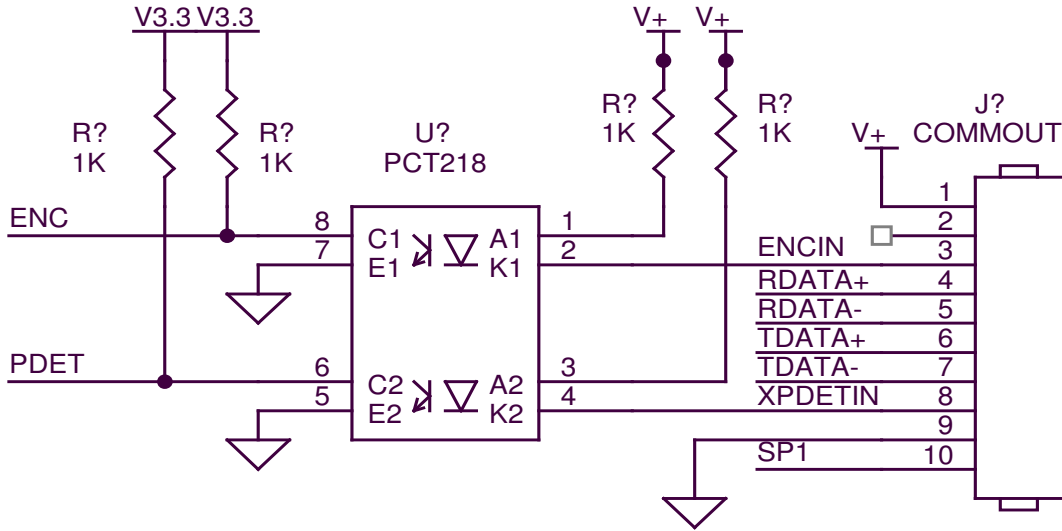

Each input requires the capability of sinking 12ma to ground as depicted in the above circuit. Connection to the optional control port requires an RJ50 connector. Below is an example of the external product detect eye supplied by Open Date Equipment Ltd. part number SEN320102.

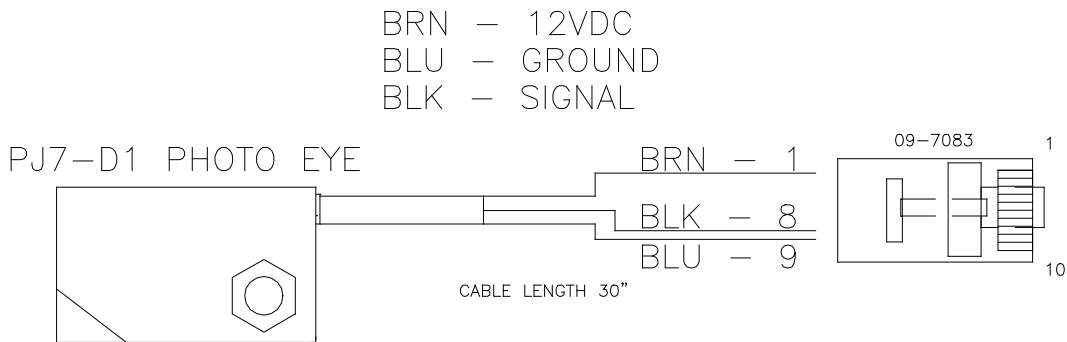

For those applications requiring accurate line speed detection an external encoder is needed.

The external encoder will provide accurate signals eliminating problems in those applications where moving product has an acceleration or deceleration component in its motion, and is often mandatory when trying to produce a reliable printed barcode. Selecting the external encoder should take into consideration a supply source that will yield the correct aspect ratio of printed height to width.

A vertical printed column contains 150 dots and spans 1/2". This equates to 0.00333 between each vertical dot placement, thusly each horizontal dot placement should be the same to maintain a perfect 300DPI ratio.

Selecting the external encoder, the line speed calculation is replaced by a scalable encoder setting ranging from 0-7 allowing a printed message to be compressed or expanded. Ideally, the external encoder should be provided to use this feature to its maximum advantage.

If the external encoder were selected to provide a resolution of 0.00333 then the external encoder set to 0 would produce the correct aspect ratio and the message can only be expanded in multiples of 0.00333 thousands of an inch. This may provide all that is required. Selecting an external encoder source that provided 0.00111 thousands of an inch would be a better choice.

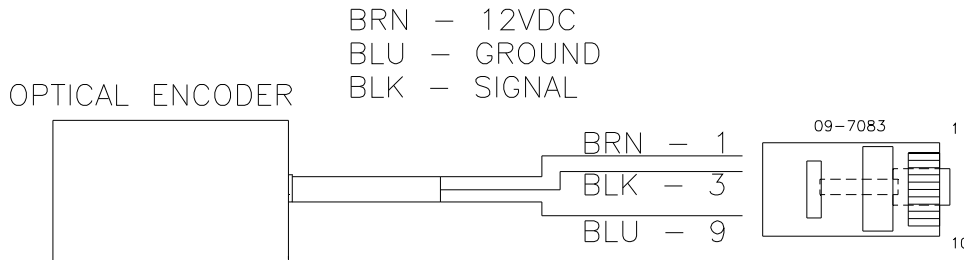

The above pictorial is an example of the connections for an external encoder.

If it becomes necessary to supply both external product detect, and external encoder, both signals can be wired into the same connector, or Open Date can supply an optional adaptor to allow connection of both cables (part number BOX320107)

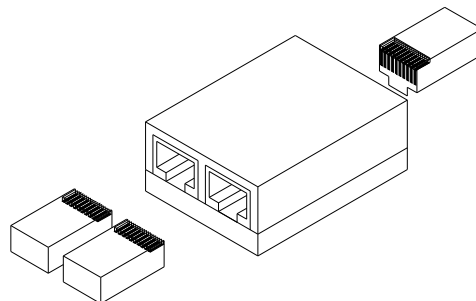

PART 8: SPECIFICATIONS

PRINTER SPECIFICATIONS

PRINT CHARACTERISTICS

Character Set:	Full alphanumeric and 20 special symbols
Standard Font:	Arial style
Logos:	up to 3 resident
Line Speeds:	From 10 to 200 fpm
Encoder Ratio:	0 to 7
Print Delay:	From 1 to 255 (approx 1.5 to 380mm)
Character Heights:	12.7mm - single line of print 5.5mm - two lines of print
Length:	24 characters (12.7mm) 48 characters (5.5mm)
Message Storage	50 Messages
Print Head to Product Distance:	Up to 6.35mm

CONTROLLER

Standard Finish:	Hi Impact ABS Black
Dimensions:	222mm x 108mm x 69mm (H x W x D)
Weight:	325 grams
Control Panel:	Touch Switches and 4x16 Line LCD

PRINT CARRIAGE

Standard Finish:	Aluminium Black Anodised
Dimensions:	76mm x 46mm x 102mm (H x W x D)
Weight:	650 grams

ENVIRONMENTAL CONDITIONS

Temperature Range:	40°F - 104°F (5°C - 40°C)
Humidity:	up to 90% relative, non-condensing
Electrical Supply:	100-250 VAC; 50-60 Hz; 0.25Amp

GENERAL

Product Detector:	IR LED convergent
Communications link	RS485 (115KBAUD 7-BITS EVEN PARITY 1 STOP BIT)

DEFAULT SETTINGS

FUNCTION	DEFAULT SETTING	RANGE
DIRECTION	<	< >
FONTS	ARIEL STYLE	USER DEFINED
INTER-CHARACTER SPACING	10	1 - 25
LANGUAGE	ENGLISH	ENGLISH / SPANISH
LINE SPEED	100	10 - 200
LOGOS	0	1 - 3
PRINT INVERSE	NORMAL	NORMAL / INVERSE
PRODUCT DETECT	INTERNAL	INTERNAL / EXTERNAL
EXTERNAL ENCODER	INTERNAL	INTERNAL / EXTERNAL
PRINT DELAY	1	1 - 255
ENCODER RATIO	4	0 - 7
MESSAGE STORAGE (OPTION PACK 1, 1.5, 2, 3)	1	1 - 50
PASSWORD (OPTION PACK 1, 1.5, 2, 3)	12345	5 CHARACTERS USER DEFINED
AUTO REPEAT (OPTION PACK 1, 2)	0	0 - 255
DATE (OPTION PACK 2, 3)	dd/dm/dy	User defined
TIME (OPTION PACK 2, 3)	hh:mm	User defined
SHIFT CODE (OPTION PACK 3)	TIMES AND CODES SET TO ZERO	User defined
DATE OFFSET (OPTION PACK 3)	OFFSET DAYS SET TO ZERO	User defined
PRODUCT COUNTER (OPTION PACK 3)	TIMES AND CODES SET TO ZERO	User defined