

# INSTALLATION, OPERATION & MAINTENANCE MANUAL

Applicable to printer model:

**Thermocode 32E**

with

**TC2-ES POWER SUPPLY V2**



*Designed and manufactured by:*

**OPEN DATE EQUIPMENT LIMITED**

**Unit 9, Puma Trade Park**

**145 Morden Rd**

**Mitcham**

**SURREY CR4 4DG**

**UNITED KINGDOM**

**Tel: +44 (0) 20 8655 4999**



Email: [sales@opendate.co.uk](mailto:sales@opendate.co.uk)

Web site: [www.opendate.com](http://www.opendate.com)

## Table of Contents

<u>Index Description</u>	<u>Page No.</u>
Standard Warranty Terms and Conditions	1
Important Safety Instructions	2
Introduction	3
Product Overview	3
Optional Extras	3
Printer Technical Information	3
Print Base Rubber Specification	3
Installation Procedure	4
Control Relays 1, 2 & 3. Programmable Functions	5
I/O Connection Diagram	6
I/O Connection Details	7
Fuses	8
Print Trigger Setting	8
Power Supply Internal Layout	9
Power Supply Front Panel	10
System Start-Up Sequence	11&12
Mini-Terminal Key Mapping	13
Status Display Software Flowcharts:	
Level 1; Operator	14
Level 2; Chargehand	15
Level 3; Engineer	16 & 17
Level 4; Manager	18
Level 5; Supervisor	19
Levels 6+; Programming	20
Quick Function Access Charts:	
Selecting a New Format	21
Editing Text Fields	22
Making Test Prints	23
Thermal Ribbon Specifications	24
Ribbon Threading Diagram	25
Daily Maintenance	26
Fault Finding & Error Messages:	27 - 38
Print Speed & Automatic Burn Compensation	39
Printer Dimensions	40
Power Supply Dimensions & Fixing Points	41
Open Date Group Companies	42

## **Standard Warranty Terms and Conditions**

Open Date thermal transfer printers carry a twelve (12) month return to base (at our discretion) warranty, with the exception of the following parts (where fitted):-

- Thermal Printhead.
- Lower roller (rubbered roller)
- Cassette springs and belts.
- Cassette rubber drive roller.
- Print base rubber or lower roller assembly.

### **Static electricity**

Warning, static electricity may damage the printer or printhead. On many film type installations, the material produces static electricity which may cause printer problems or printhead failure. Open Date does not accept any warranty claims for damage to the printer or printhead caused by static electricity.

If you are in doubt about your installation please contact your supplier.

### **Printhead warranty**

The printhead assembly carries a 50 kilometres or 12 months warranty which ever is the soonest. Should the printhead fail during this period, the replacement printhead will carry the balance of the existing warranty.

Refer to the ribbon specifications sheet on page 24, check the correct width of thermal transfer ribbon is being used and has the appropriate silicone back coating to protect the printhead.

The printhead warranty will not be valid if:-

- The full width ribbon is not being used. This will be apparent by excessive wear on the edges of the printhead.
- Mechanical damage is apparent from abuse.
- The spy chip board has been removed or damaged in any way.
- Cleaning procedures have not been followed.
- Installation and maintenance procedures are not correct.
- The print base used is not as specified (see page 3).
- The printhead angle has not been set up correctly.
- Static electricity is found.
- Recommended Open Date ribbon is not being used (see page 24 for ribbon specifications).
- Printing substrate or ribbon is found to be abrasive.
- Operating temperature is outside of the range 0°C to 60°C.

We reserve the right to charge for components replaced during the warranty period which are damaged due to any of the above conditions not being followed or met.

### **Printhead Spy Chip**

Contained within the printhead assembly is a small microchip this is programmed when the head is first assembled and tested to retain the following information:-

- Printhead resistance value (ohms).
- Printhead width (Dots).
- Printhead serial number.
- Printhead data lines.
- Programmed factory date.
- Printhead angle.

During printer start up the spy chip is read by the software to determine the width of printhead. The software then automatically adjusts the resistance value to compensate for the correct print burn calculations. Whilst printing the spy chip continually records the print distance achieved during the life of the printhead.

Recorded printhead data can be viewed through the Service menu on the mini-terminal display.

**IMPORTANT SAFETY INSTRUCTIONS**

1. Read these instructions carefully. Follow all warnings and instructions marked on the product.
2. Always disconnect the printer and Power Supply from the mains electrical supply before attempting to clean or service the product.
3. Never operate the printer, unless it is installed within the mounting frame supplied. When installed correctly, the gap between the printer and print base should be nominally 1mm.
4. Do not use the product near water. Never spill liquid of any kind on to the product.
5. Do not place this product on an unstable stand, table or machine. It may fall causing serious injury to the operator or damage to the product.
6. Never insert objects of any kind into this product through any openings or gaps as they may touch dangerous voltage points or short circuit parts that could result in fire or electric shock.
7. This product should only be connected to the type of electrical supply as indicated on the label located on the rear of the power supply.
8. Ensure that the printer connection cable is fully secured to the printer and power supply with the screws supplied. Failure to do this will result in the machine not being properly earthed.
9. Use only the power cable supplied with the product. The cable supplied is three core, utilising one wire as a grounding conductor. This must be connected to a suitable earth point at the electrical supply. This is a safety feature. If any doubt arises in trying to connect the power cable, please contact the manufacturer or the agent who supplied the product.
10. Do not allow anything to rest on the power cable. Do not locate the product where people could walk on the cable.
11. If an extension cable is used with this product, make sure that the total ampere ratings of the equipment plugged into the extension cable does not exceed the extension cable ampere rating. Also make sure that the total rating does not exceed the fuse rating.
12. Do not service this product yourself as opening or removing guards may expose you to dangerous voltages, major burns and other risks. Refer all servicing to qualified personnel.
13. Do not attempt to use to use this product in areas where explosive gases or substances are present.
14. Under the following conditions always disconnect the electrical supply and refer to a qualified service engineer.
  - a. If the power cable is damaged or frayed.
  - b. If the printer connection cables are damaged in any way.
  - c. If liquid has been spilled into the product has been exposed to water.
  - D. If the product does not operate normally when the operating instructions are followed.
15. Adjust only those controls covered by these instructions. Improper adjustment could result in permanent damage, requiring qualified technicians to restore the product to normal operating conditions.
16. Do not touch the printer or power supply with wet or moist hands.
17. Do not use the printer without thermal transfer ribbon as the printhead is likely to become damaged.

## Introduction

- This manual describes the basic installation, operation and maintenance of Thermocode 32E printers.
- Print formats are designed using an external computer running appropriate software then downloaded to the printer.
- The mini-terminal is used to select and modify pre-stored formats, variables and printer parameters.
- The mechanical adjustments that can be made to the printer are minimal. Normally the printer is installed in a standard frame which sets the correct clearance from the print pad. To ensure proper printer operation the correct detailed dimensions must be obtained from Open Date when constructing custom frames or mountings.

### Product Overview

The following components are supplied ready for installation.

1 Thermocode 32E printer.

1 Power supply unit type TC2-ES PSU V2

1 Mini terminal display.

1 Power supply interconnection lead 1.5 metres long (also available in 3, 5 or 6 metre lengths).

1 roll of thermal transfer ribbon, to suit printer (wax/resin quality).

1 USB stick containing printer manual, firmware and fonts.

1 Printhead cleaning kit consisting off 50 printhead cleaning wipes (Isopropyl alcohol)

1 Serial programming lead (3 metres)

1 Print pad, to suit printer.

1 Codesoft Premier package, (Windows design software) with Codesoft installation manual (optional).

### Optional Extras

Standard or custom designed mounting frame

### Printer Technical Information

- Maximum print area - 32 x 30mm.
- Printhead resolution - 12 dots per mm (300 dots per inch).
- 3.4 Megabytes memory for storing fonts, graphics and custom designed print formats.
- Single direction printing.
- Print designs are stored along with all parameters, allowing quick access for printing.
- Automatic updating of printer memory when editing formats.
- Automatic selection of supply voltage from 100 to 240Vac, 50/60hz, single phase.
- Real Time/Date printing with specified offsets if required.
- Sequential numbering and Barcode printing.
- All text, graphics, lines and boxes can be printed in all four orientations (0, 90, 180, 270 degrees).

### Print Base Rubber Specifications

Hardness: - "40 - 50 Shore A" Silicone Rubber. (Colour mid blue)

Thickness: - 4.75mm Silicone Rubber bonded to 4.75mm thick Aluminium sheet.  
(Minimum 2.0 thickness)

Flatness: - Supplied with ground surface finish, -0.03mm to +0.03mm as per printhead heater specification.

## Installation Procedure

### **IMPORTANT**

**To minimise risk of personal injury and avoid damage to equipment before starting installation:**

- **Read the safety information in this manual (page 2).**
  - **Ensure that the parent machine is switched off and securely isolated from the mains supply.**
  - **Make all electrical connections after the equipment is mounted and secured.**
  - **Do not apply power to printer or parent machine until connections have been checked**
1. Install the Thermocode 32E printer in the mounting frame, ensuring that the orientation for the application and clearance between the printer and print base rubber is correct. **Consult Open Date before using a non-standard frame or mounting.**
  2. Connect the printer and power supply using the interconnection lead supplied. The lead has been specifically designed, so it cannot be fitted incorrectly. Ensure that the plugs and sockets are inserted fully before tightening the fixing screws.
  3. As a minimum, each installation must have an automatic trigger signal\* from the parent machine, sent at the point in the process where a print is desired. This signal can be:
    - A process controlled relay within the parent machine (voltage free)
    - A process controlled 24 Volt pulsed output signal .
    - A stand-alone micro switch.
    - A stand-alone PNP / NPN sensor suited to the process / substrate (e.g.; proximity, colour mark, contrast)Refer to pages 6 & 7 for details of connections according to the chosen print triggering method.
  4. Care must be taken when using print trigger signals not under control of the parent machine to prevent unexpected / false triggering that could damage the printer or associated equipment.
  5. Up to three interface relays are available in the PSU to allow printer status to be communicated to the parent machine or external equipment such as beacons & sounders.  
Refer to page 5 for details of available software configured relay functions & set up)  
See pages 6 & 7, TC2-ES Power Supply manual for relay connections and maximum ratings.

### **\*NOTE!**

By default printing occurs immediately on receiving a print trigger signal. The response time to print trigger signals can be delayed using the Supervisor menu on the Mini-terminal display. Selecting "Delay Menu" allows delays from 0 – 999mS to be set (see page 19).

## Control Relays 1, 2 & 3. Programmable Functions

The **TC2-ES** power supply contains three volt free, floating contact relays used to interface with the parent machine.

(see pages 6 & 7 for relay connections and maximum ratings)

Relay functions can be changed using the mini-terminal to suit specific requirements.

Options (default) are shown below. (To change relay function see software flowchart, page 20 )

### Relay 1 (4 options)

**<0> Stop Machine**

The relay operates after each print cycle giving a trigger/inhibit signal to the parent machine after printing or when the cassette is removed.

**<1> Sequence** (default software setting)

The relay operates after each print cycle giving a trigger/inhibit signal to the parent machine after printing.

**<2> Ready**

The relay operates when print images are being generated etc. (When the printer is off line)

**<3> Future development**

**<4> 100ms pulse**

The relay is pulsed for a 100 milliseconds

### Relay 2 (5 options)

**<0> Start Machine**

The relay operates after each print cycle giving a trigger/inhibit signal to the parent machine after printing or when the cassette is removed.

**<1> Low Ribbon** (default software setting)

The relay operates when the amount of Thermal Ribbon left in metres reaches a pre-programmed amount, and is visually indicated to the operator "Low Foil" on the status line of the mini-terminal display.

**<2> Ready**

The relay operates when print images are being generated etc. (When the printer is off line)

**<3> 100ms pulse**

The relay is pulsed for a 100 milliseconds

**<4> 100ms pulse**

The relay is pulsed for a 100 milliseconds

### Relay 3 (4 options)

**<0> Fault Only**

The relay operates when the printer's internal sensors detect a fault or error condition. Typical examples of this are when the Cassette is removed or if the Thermal Ribbon is broken.

**<1> Fault & Ready** (default software setting)

The relay operates as option 1, but will also operate when print images are being generated etc. The relay should be connected to inhibit the parent machine should any printer fault occur.

**<2> Future development**

**<3> 100ms pulse**

The relay is pulsed for a 100 milliseconds

**<4> 100ms pulse**

The relay is pulsed for a 100 milliseconds

**Power Supply I/O Connection Diagram**

**DISCONNECT FROM THE MAINS SUPPLY BEFORE OPENING THE CASE**  
**DO NOT WORK ON THE PSU WITH THE MAINS CABLE CONNECTED**

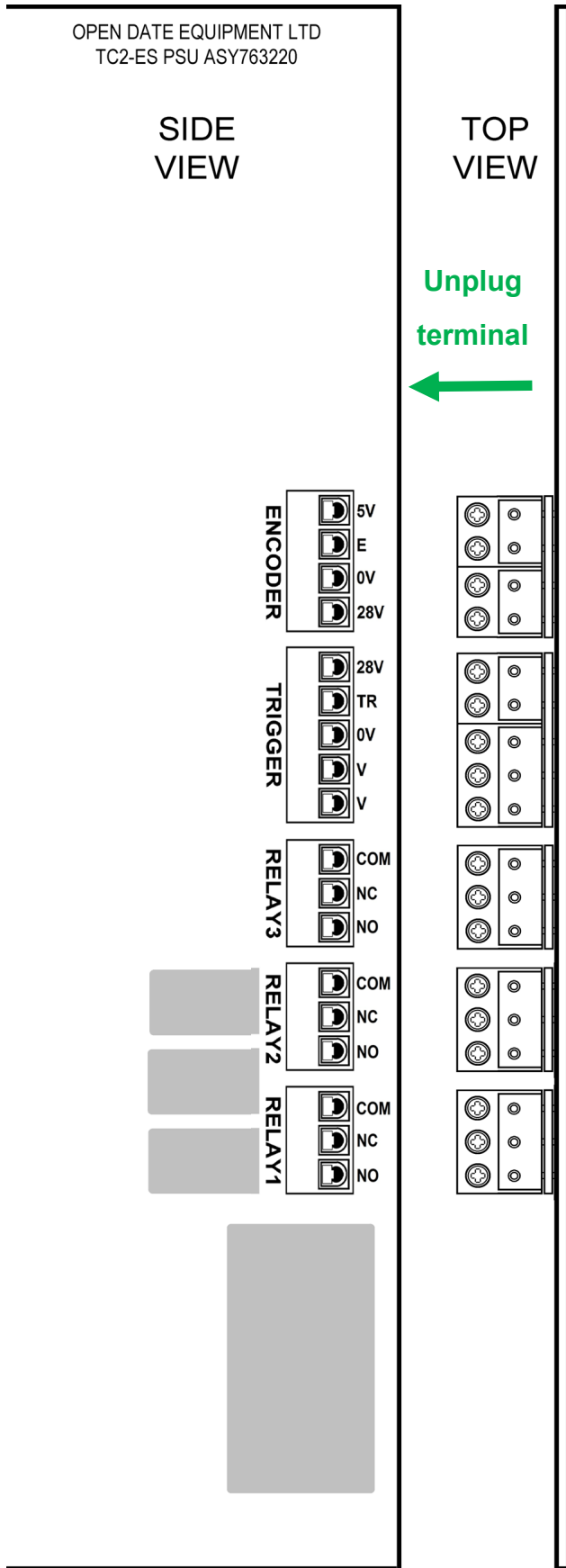

Illustration shows side and top views of the I/O terminals for interface to external equipment.

Do not apply excessive downward pressure on the terminals when tightening screws.

The terminals can be unplugged in the direction shown.

Refer to page 7 for connection information.

- ENCODER (J5)**  
**5V** +5V encoder power  
**E** Encoder pulse input  
**0V** 0V encoder power  
**28V** +28V encoder power.
- TRIGGER (J4) (see triggering, page 7)**  
**28V**  
**TR** Volt free trigger  
**0V** GND  
**V** Voltage trigger.  
**V** Voltage trigger.
- RELAY 1/2/3 (J1,2,3)**  
**COM** Common terminal  
**NC** Normally closed. Connected to COM when relay is not energised  
**NO** Normally open. Connected to COM when relay is energised



## I/O Connection Details

**TO AVOID DAMAGE AND RISK OF ELECTRIC SHOCK CONNECTIONS MUST ONLY BE MADE WITH THE POWER CABLE DISCONNECTED.**

(Refer to the diagram on page 6.)

The protective earth (mains conductor), the 0V terminals of the internal power supply modules, the 0V of the print head and the 0V from the printer electronics are all common.

### ENCODER (J5)

Used with continuous printers only.

Connect encoder +V wire to **5V** or **28V** (depending on encoder voltage)

Connect encoder 0V wire to **0V**

Connect encoder pulse output (Q) to **E**

Maximum current from **5V** terminal; 100mA

### **PRINT TRIGGERING:**

See page 8 for selection of Leading or Trailing print trigger.

### Volt free triggering

Use external relay or switch with volt free contacts.

Connect the **TR** terminal to one contact.

Connect EITHER **28V** or **GND** to the other contact.

**>>>Do not connect the 28V and GND terminals together.<<<**

### Voltage triggering

Connect voltage trigger source to terminals **V** and **V** Any voltage from 10 to 30V may be used, polarity is un-important.

### PNP/NPN sensor triggering

Connect sensor +V wire (usually brown) to **28V** terminal

Connect sensor 0V wire (usually blue) to **0V** terminal

Connect sensor output wire (Q, usually black or white) to **TR** terminal (See \* below)

**\*Diode type 1N4007 may needed in the Q wire from the sensor for correct operation. (anode to Q, cathode to TR.)**

The PSU configures automatically for PNP or NPN sensors.

### RELAY 1,2,3

SPCO relays with voltage free contacts

(Maximum contact ratings; 0.6A @ 125Vac, 0.6A @ 110Vdc, 2A @ 30Vdc)

Relay is energised when blue LED on front panel is lit

**COM** is connected to **NC** when the relay is not energised.

**COM** is connected to **NO** when the relay is energised.

## Location of Fuses and Print Trigger Mode Setting

**DISCONNECT THE MAINS CABLE BEFORE OPENING THE CASE  
DO NOT WORK ON THE PSU WITH THE MAINS CABLE CONNECTED**

Diagram below shows location of DC fuses and print trigger setting link on the rear of the main pcb, accessible from the right hand side of the PSU.

Attention is drawn to the warning label indicating the presence of dangerous voltages on the PCB.

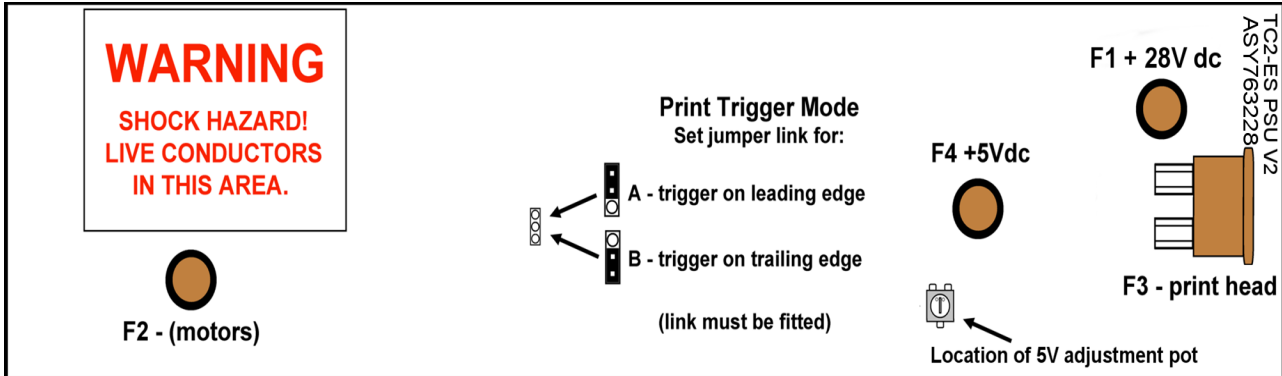

### FUSES and Ratings

**FUSES MUST BE REPLACED WITH THE SAME TYPE AND RATING**

Located on the main PCB:

No.	Ref.	Type	Circuit
F1	FUS783022	T2A Radial	28V (not print head), 5V dc/dc converter & 9V regulator.
F2	FUS783022	T2A Radial	48V stepper motor drives.
F3	FUS763029	7.5A automotive	28V switched output to print head.
F4	FUS783022	T2A Radial	5V output from dc/dc converter.

Located under the mains inlet on the front panel:

F5	FUS503521	T3.15A HRC 20 x 5mm	Mains.
----	-----------	---------------------	--------

Note: The 5V and 9Vdc supplies are derived from the 28Vdc supply. If fuse F1 blows the 5 and 9V supplies will not be present.

### PRINT TRIGGER SETTING

Printing can be triggered on the leading (trigger switch closes) or trailing (trigger switch opens) edges by setting the jumper link shown above to the A or B position.

**Position A** Printing is triggered at the start of a trigger pulse (leading edge).

**Position B** Printing is triggered at the end of a trigger pulse (trailing edge).

**NB.** The jumper link must be fitted to position A or B. A trigger pulse will not be generated if the link is not fitted.

### Power Supply Internal Layout

View inside PSU showing layout and main components (with part numbers).  
**Disconnect supply before removing cover.**

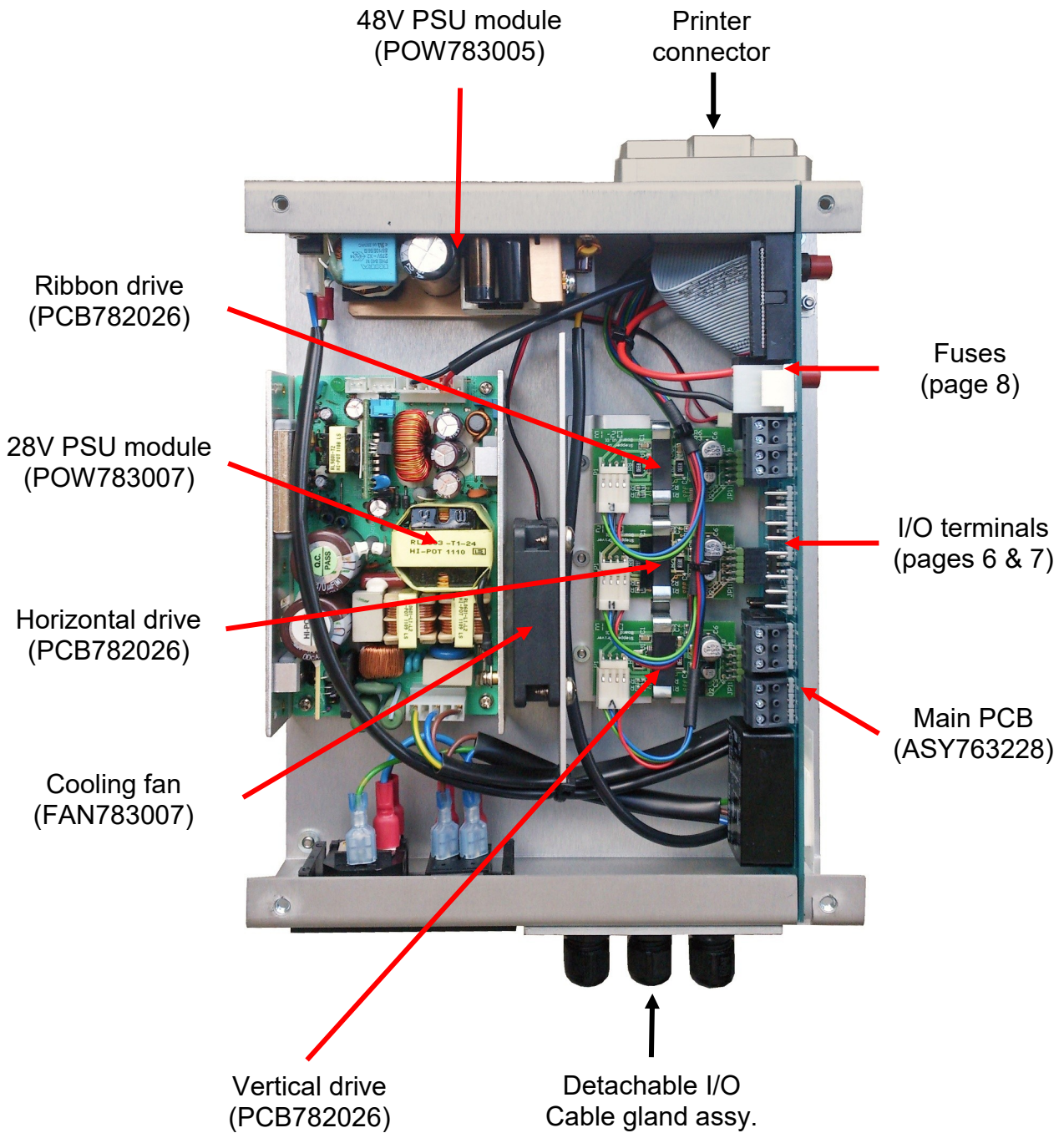

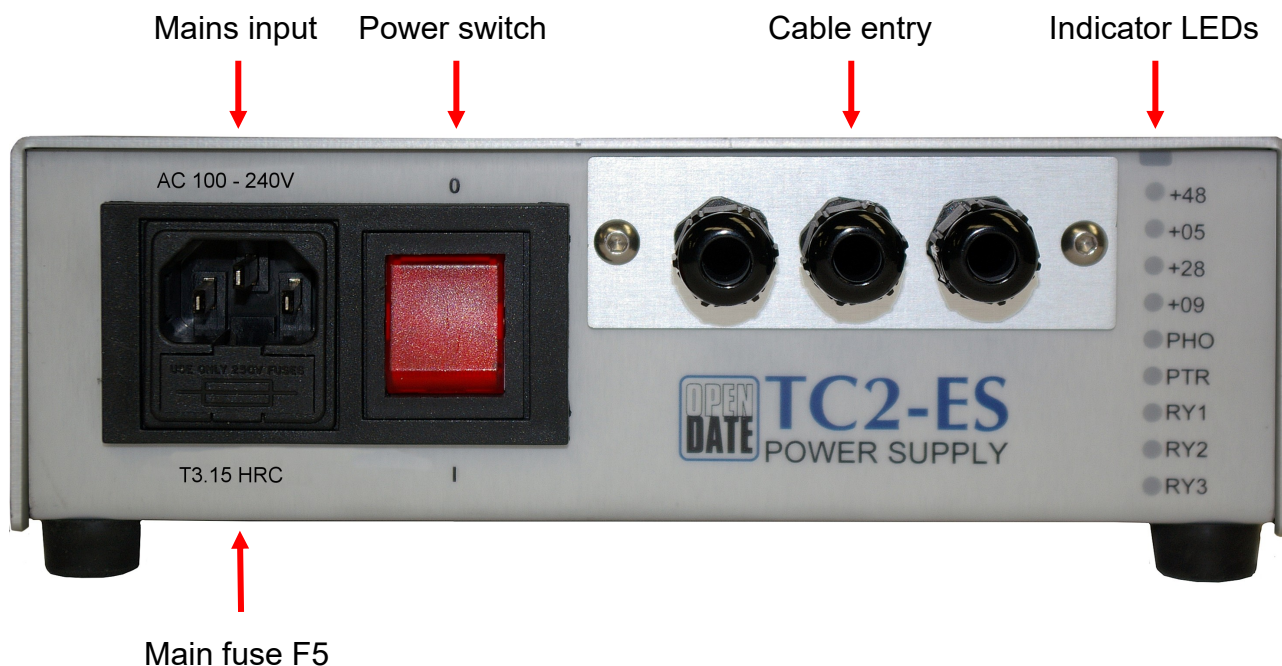
**Power Supply Front Panel****AC mains input:**

Accepts IEC C13 power cable.

Switch PSU off before disconnecting

**SHOCK HAZARD!** Disconnect the power cable **BEFORE** opening the case.

**DO NOT** work on the PSU with the power lead connected.

**Main fuse F5:**

Fuse located in rear compartment of drawer.

For continued protection always replace fuse with the same type and rating.

**Cable entry:**

Release by undoing the two screws. The terminals inside can be unplugged. This makes the PSU easy to replace.

**Indicator LEDs:**

<b>+48</b>	48Vdc present. (motor drives).
<b>+05</b>	5Vdc present.*
<b>+28</b>	28Vdc present.
<b>+09</b>	9Vdc present.* (keypad display).
<b>PHO</b>	Print Head Output. 28V supply to print head is active when lit.
<b>PTR</b>	Print Trigger. Lights briefly when a print trigger is received.
<b>RY1</b>	Relay 1 energised.
<b>RY2</b>	Relay 2 energised.
<b>RY3</b>	Relay 3 energised.

\*The 5 & 9V supplies are derived from the 28V supply. No 28V supply means no 5 or 9V supply.

## System Start Up Sequence

Ensure if a standard mounting frame is used, it is fully closed before switching on the printer.

After power up the mini-terminal screen briefly shows the information below:

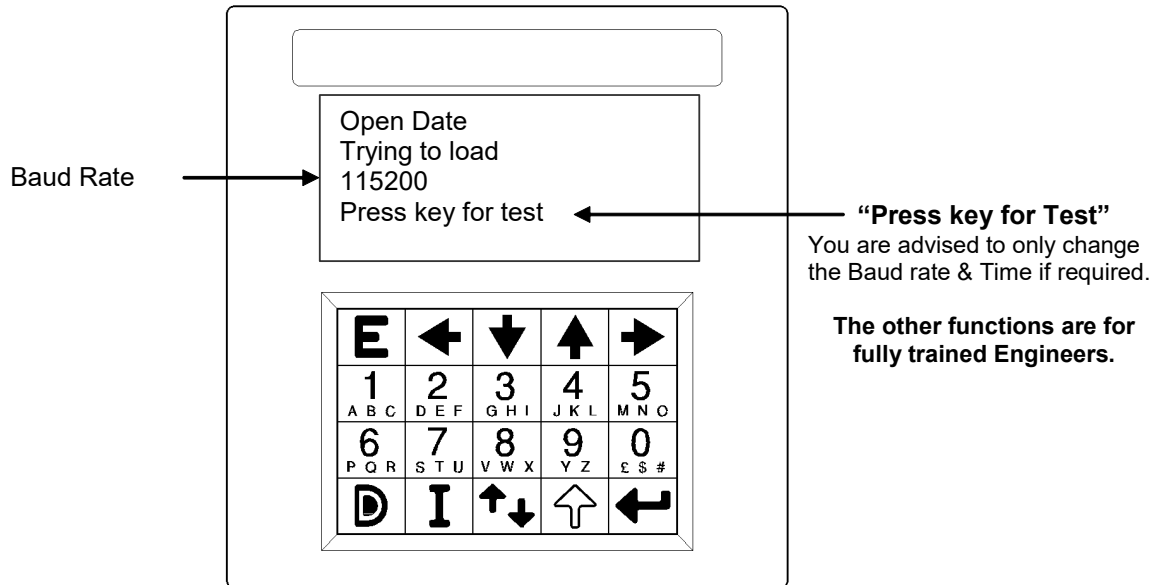

The system then loads the TC2 software. When this is complete the screen changes, showing:

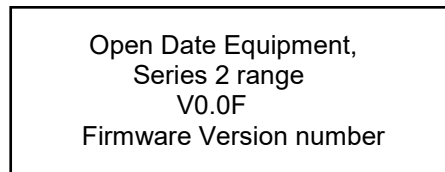

After a few seconds, the printer will perform a standard sequence of operations to determine:

- print head width.
- maximum print length.
- height of printer above print base

These parameters are used by the software to determine the maximum printable area (and therefore the model of printer) and the correct print head height above the print base.

The next page shows the information displayed on the mini terminal screen on completion of the start up sequence.

### System Start Up Sequence continued

When the start up sequence has been successfully completed the mini-terminal display will change to show the following information:

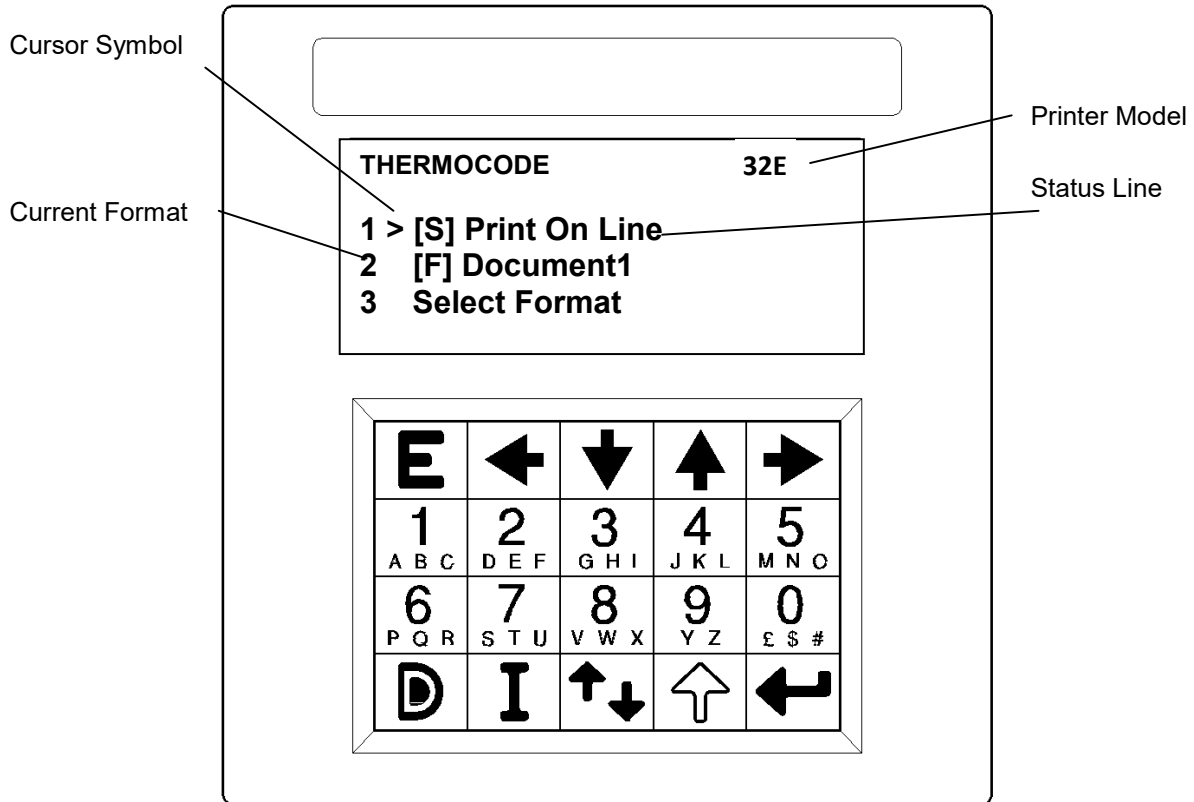

[S] Status Line

This line on the display shows the current status of the printer. If errors have occurred the display show "error" and by either pressing the enter key when the cursor is next to the error or by just pressing "1" on the keypad all errors will be listed.

[F] Document1

This line on the display shows the current format image that is ready to print, pressing number 2 on the keypad would allow the user to edit all functions relevant to the design.

#### **Accessing menu functions - Note!**

Accessing of all menu functions can be done by either of two ways:-

Moving the cursor next to the function you wish to go to and press "Enter".  
Simply press the required number next to the function you require.

**See next page for a full description of the keys on the Mini-Terminal display unit.**

MINI TERMINAL (Key mapping)

**LEFT ARROW KEY**  
 Moves the cursor to the left when editing, or to toggle different fields  
 Format selection display A to Z

**ESCAPE KEY**  
 Returns to the previous menu  
 Does not save any data changed

**CHARACTER INPUT KEYS**  
 Used to access menu options  
 When selecting formats allow the user to move through the pages  
 1 = move 1 page up (3 lines)  
 6 = move 1 page down (3 lines)

**DELETE KEY**  
 Deletes character when editing variable fields.  
 Used to select a format with PSMT Mini Terminal

**INSERT KEY**  
 When editing text fields, allows the insertion of special characters not shown on the key pad.  
 When pressed will display a list of options allowing a choice of character styles. (Punctuation, French, German etc

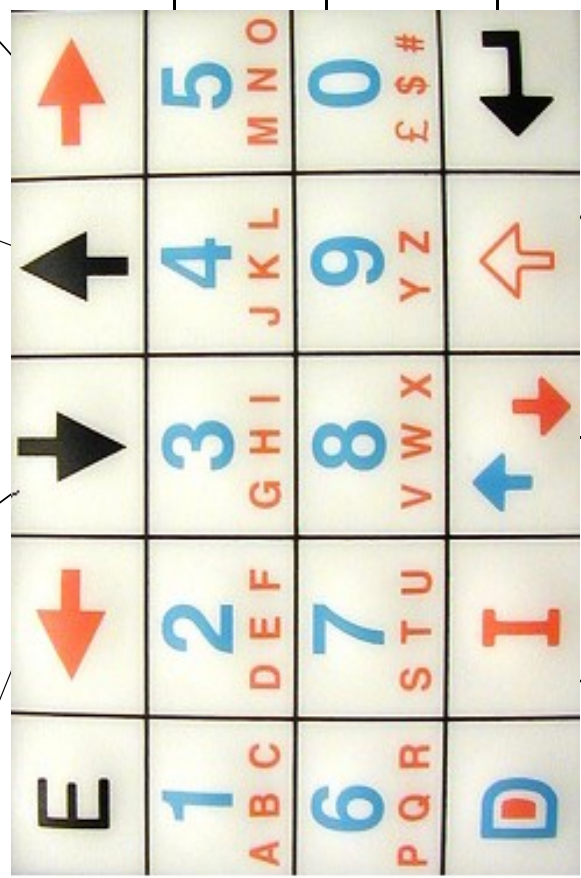

**DOWN ARROW KEY**  
 Moves the cursor down to the next field on the screen

**UP ARROW KEY**  
 Moves the cursor up to the next field on the screen

**RIGHT ARROW KEY**  
 Moves the cursor to the right when editing, or to toggle different fields  
 Format selection display Z to A

**CHARACTER INPUT KEYS**  
 Used to access menu options  
 When editing text fields, allows the input of characters shown on the keys. This dependent on how the shift and alphanumeric keys have been activated.  
 The key may need pressing more than once to display the required alpha character

**ENTER KEY**  
 Accepts your selection.  
 Returns to the previous menu and saves any data changed after editing

**ALPHANUMERIC KEY**  
 When editing allows the user to change between alpha and numeric characters  
 Moves the cursor to the end of lists  
 When editing parameter or system variables pressing once decrease the value by one

**SHIFT KEY**  
 When editing text fields, allows the user to select between upper or lower case characters  
 Moves the cursor to the top of lists  
 When editing parameter or system variables pressing once increments the value by one

**Status Display Software Flowchart—Level 1: OPERATOR**

**STATUS DISPLAY SOFTWARE FLOWCHARTS (Level 1: OPERATOR)**

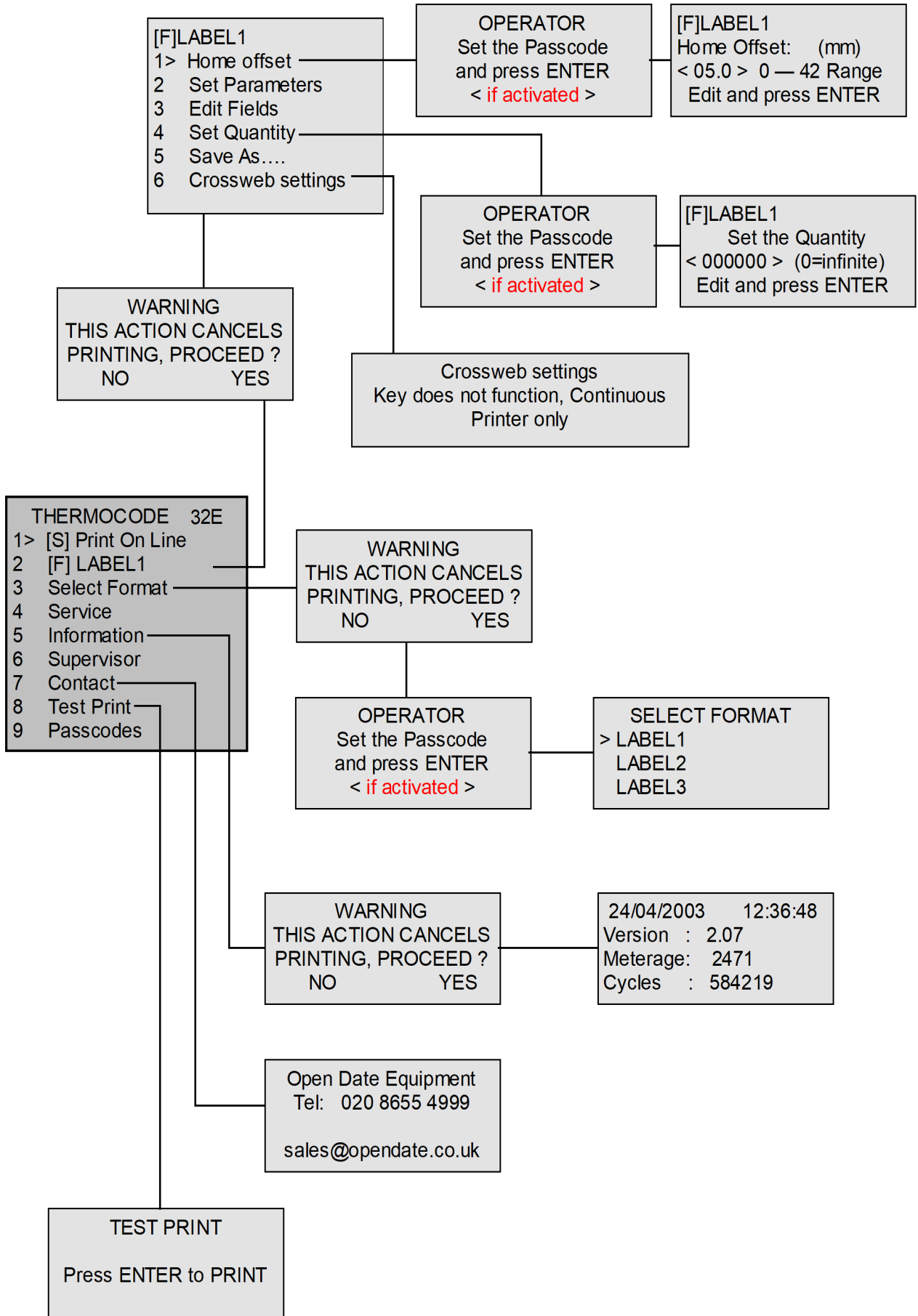



**Status Display Software Flowchart—Level 2: CHARGEHAND**

**STATUS DISPLAY SOFTWARE FLOWCHARTS (Level 2: CHARGEHAND)**

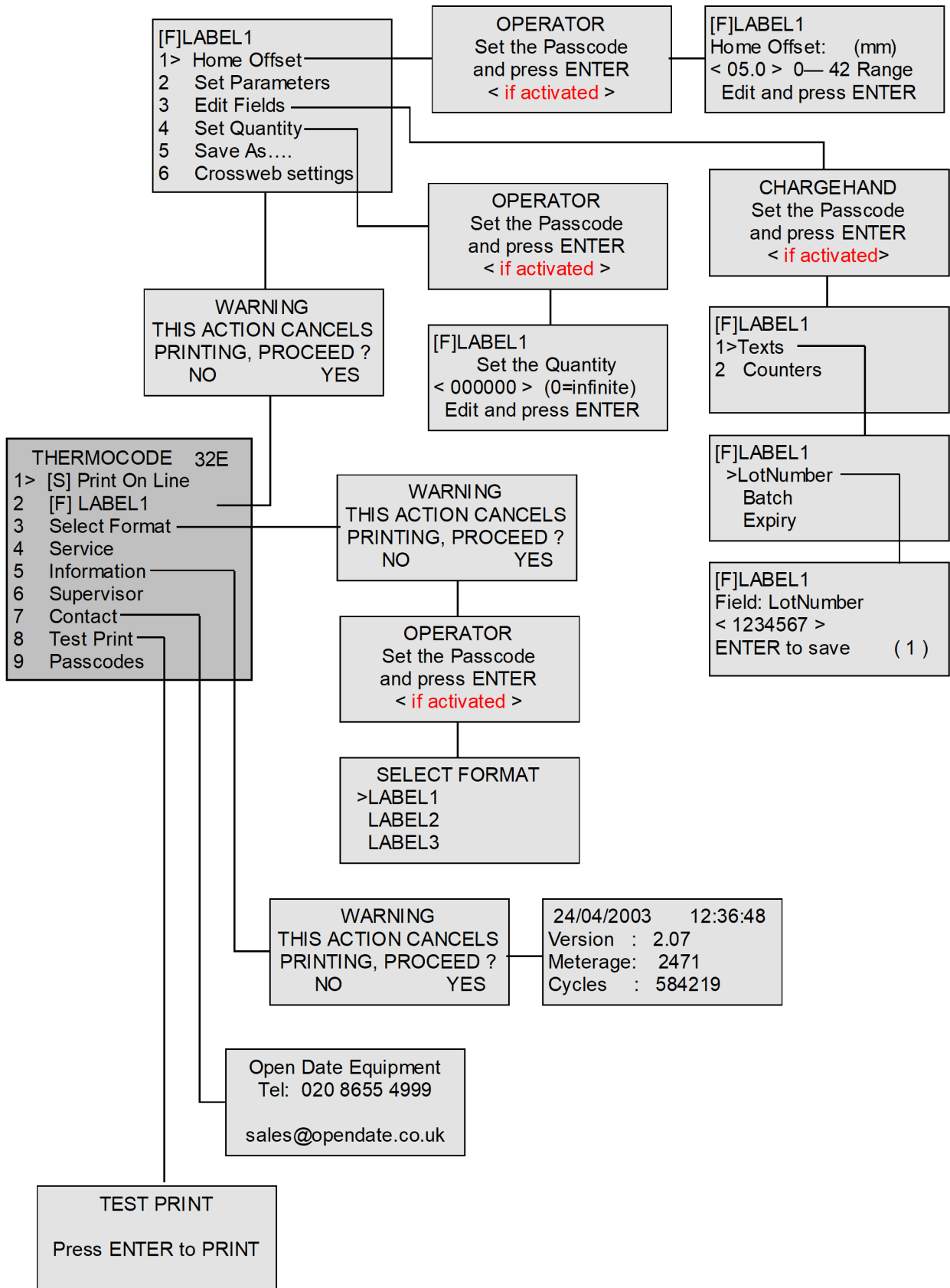

**Status Display Software Flowchart—Level 3: ENGINEER**

**STATUS DISPLAY SOFTWARE FLOWCHARTS (Level 3: ENGINEER)**

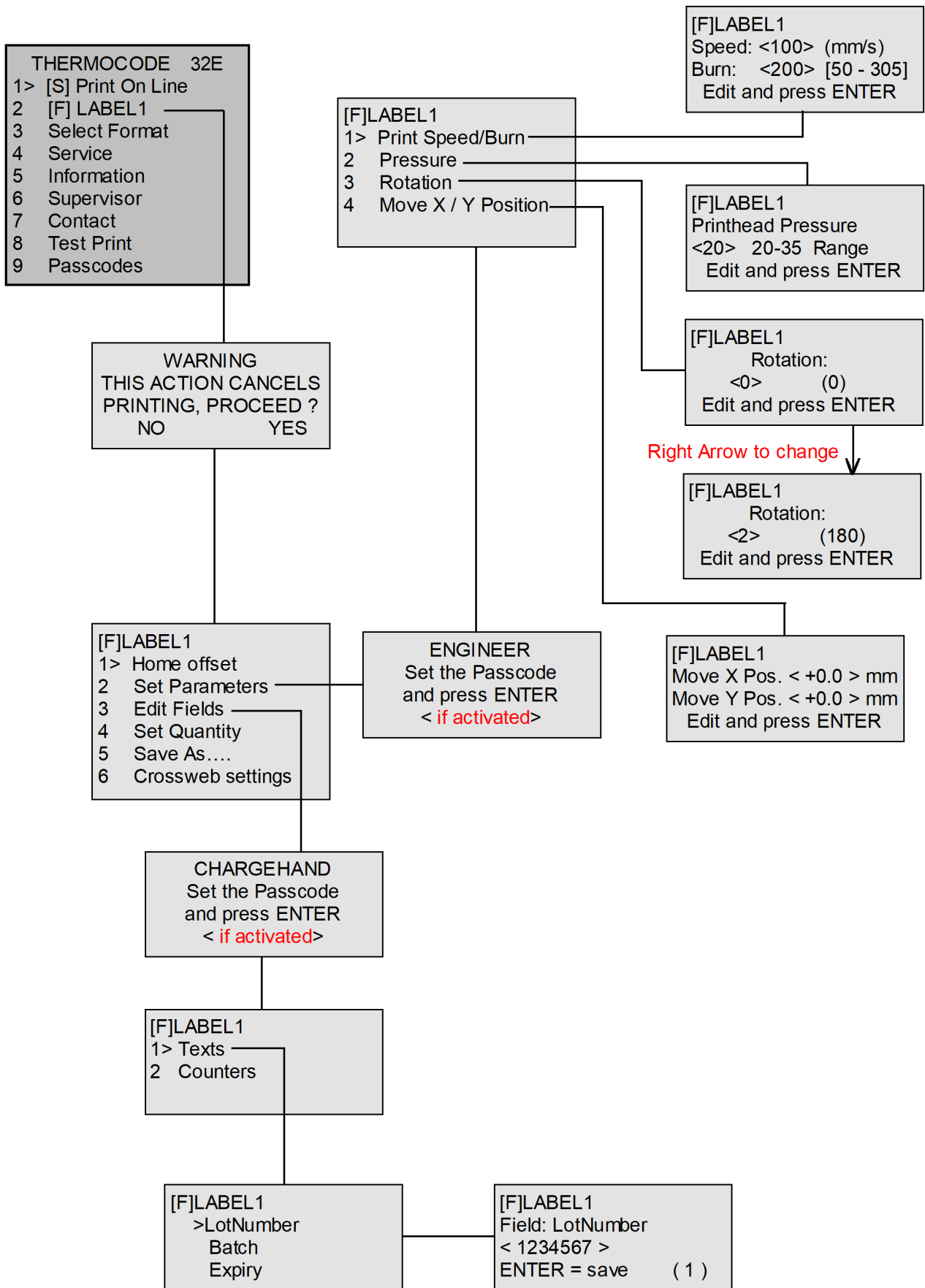

**Status Display Software Flowchart—Level 3: ENGINEER**

**STATUS DISPLAY SOFTWARE FLOWCHARTS (Level 3: ENGINEER)**

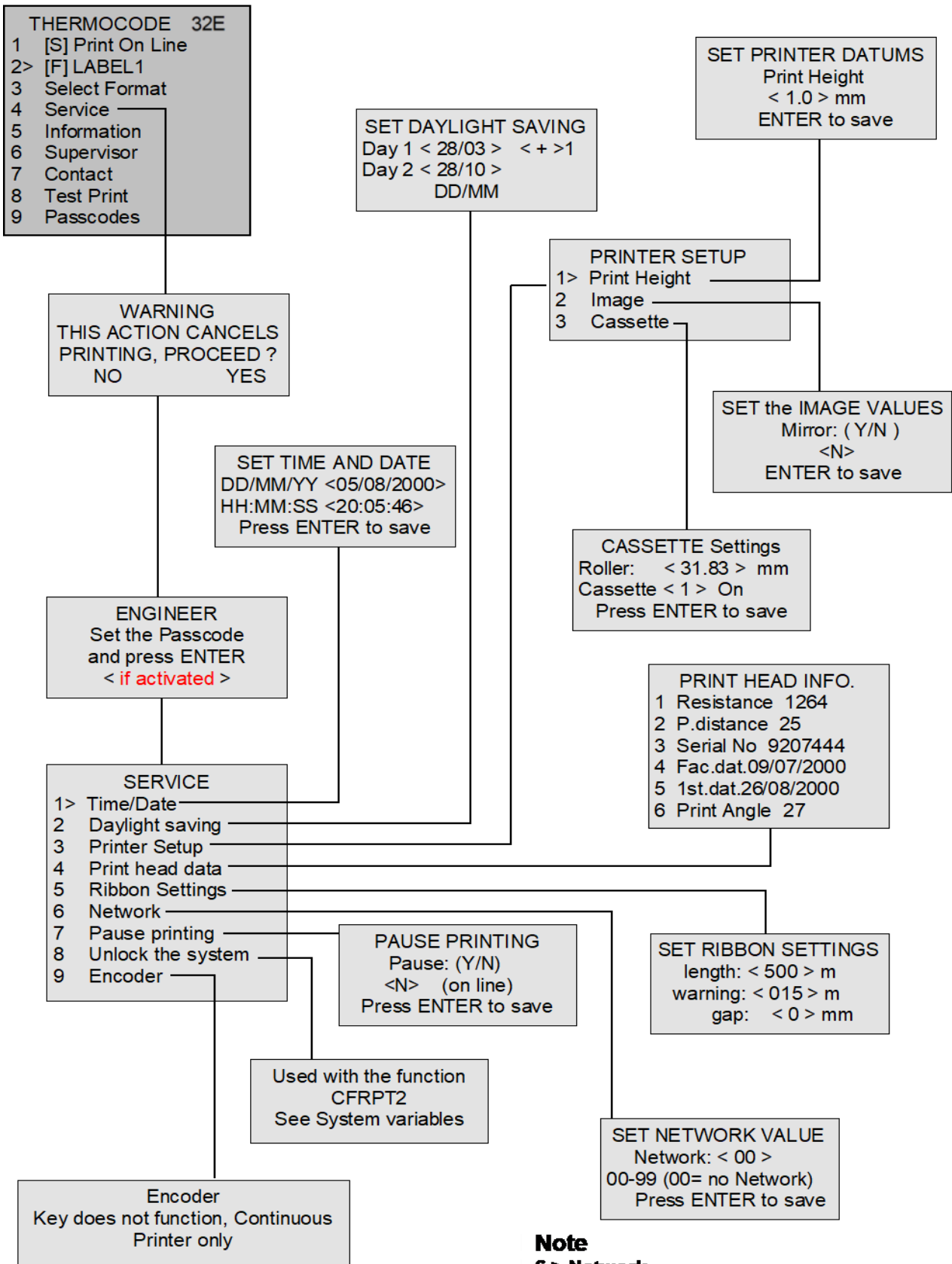

**Note**  
**6 > Network**  
**Refers to Open Date's Network system**  
**and is no longer available**

**Status Display Software Flowchart—Level 4: MANAGER**

**STATUS DISPLAY SOFTWARE FLOWCHARTS (Level 4: MANAGER)**

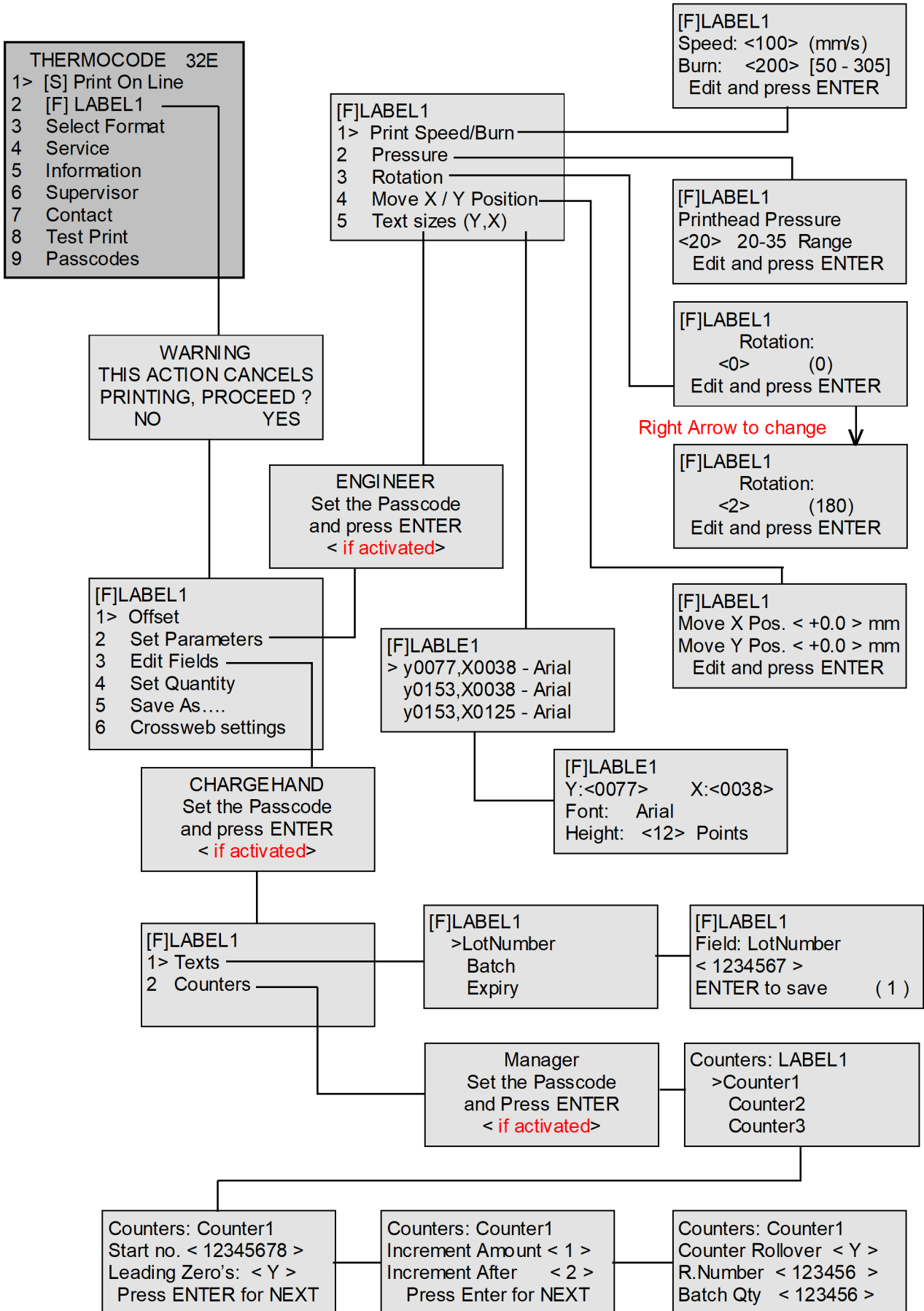

**Status Display Software Flowchart—Level 5: SUPERVISOR**

**STATUS DISPLAY SOFTWARE FLOWCHARTS (Level 5: SUPERVISOR)**

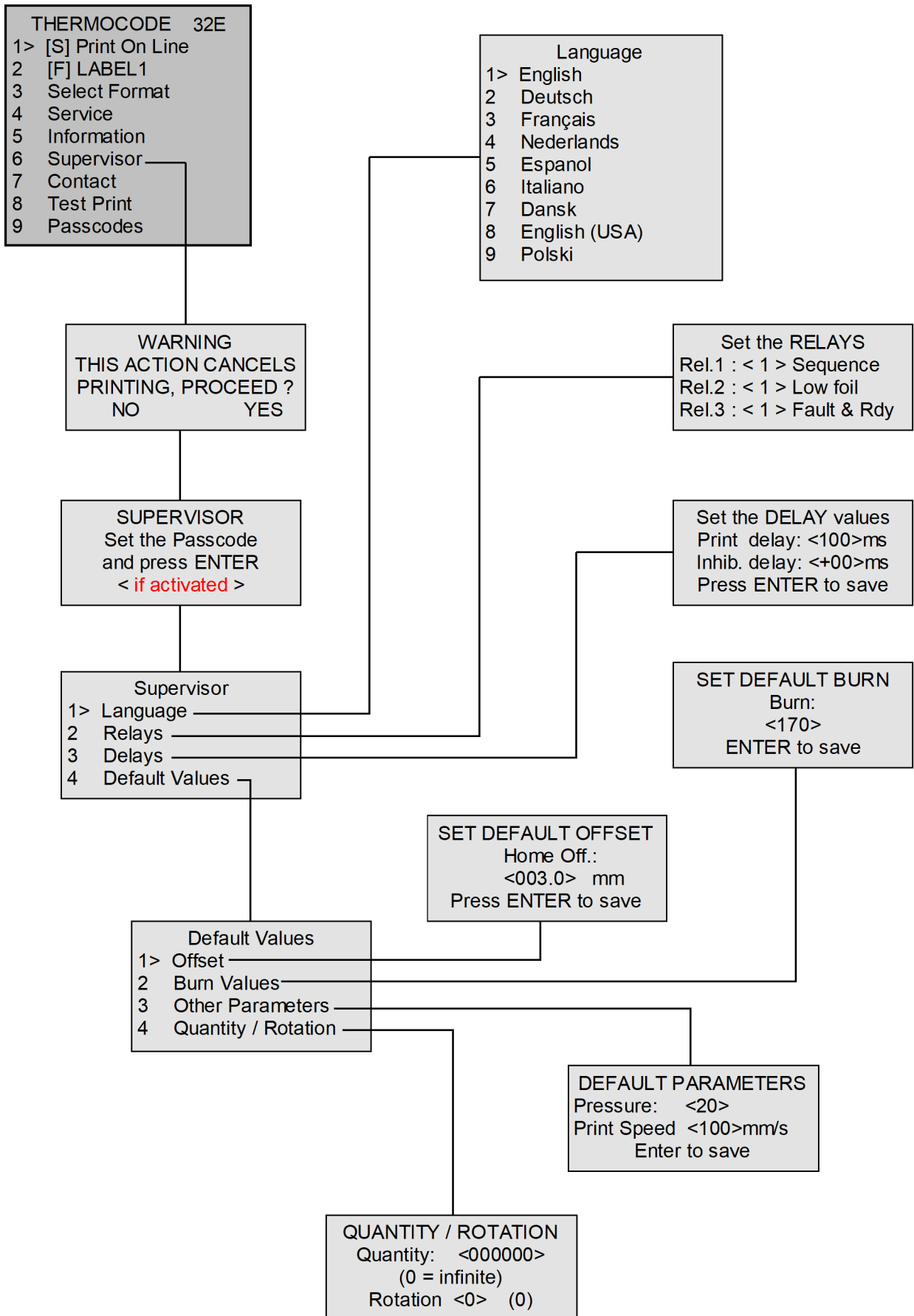

**Status Display Software Flowchart—Level 6 +: PROGRAMMING**

Common to all Thermocode 2 Printer

**STATUS DISPLAY SOFTWARE FLOWCHARTS** (Level 6 +: PROGRAMMING)

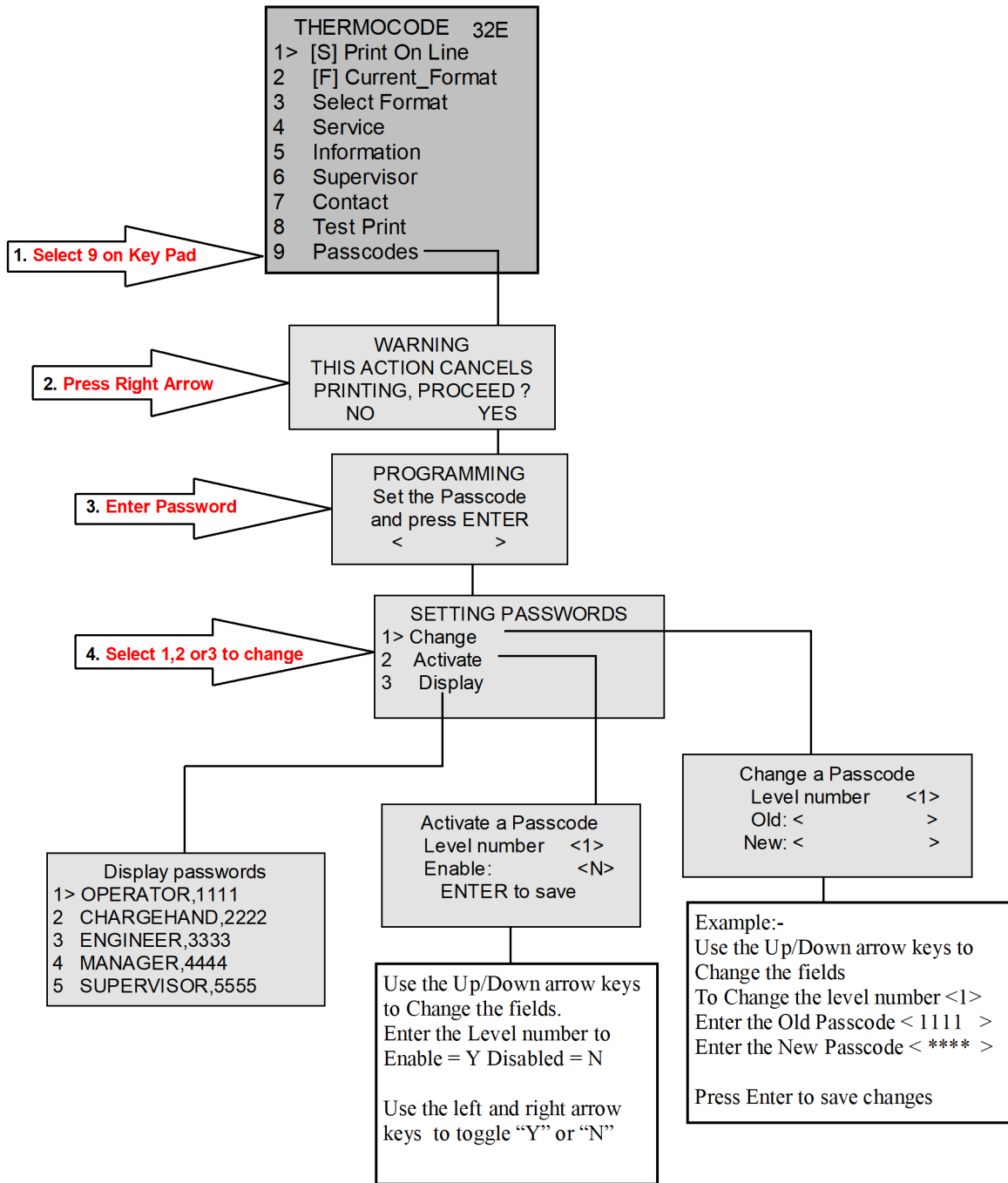

Levels 6, 7, 8 & 9 would have to be changed, using RecoverMode or Codesoft.

**Status Display Software Flowchart—SELECTING NEW FORMAT**

**Selecting a New Format**

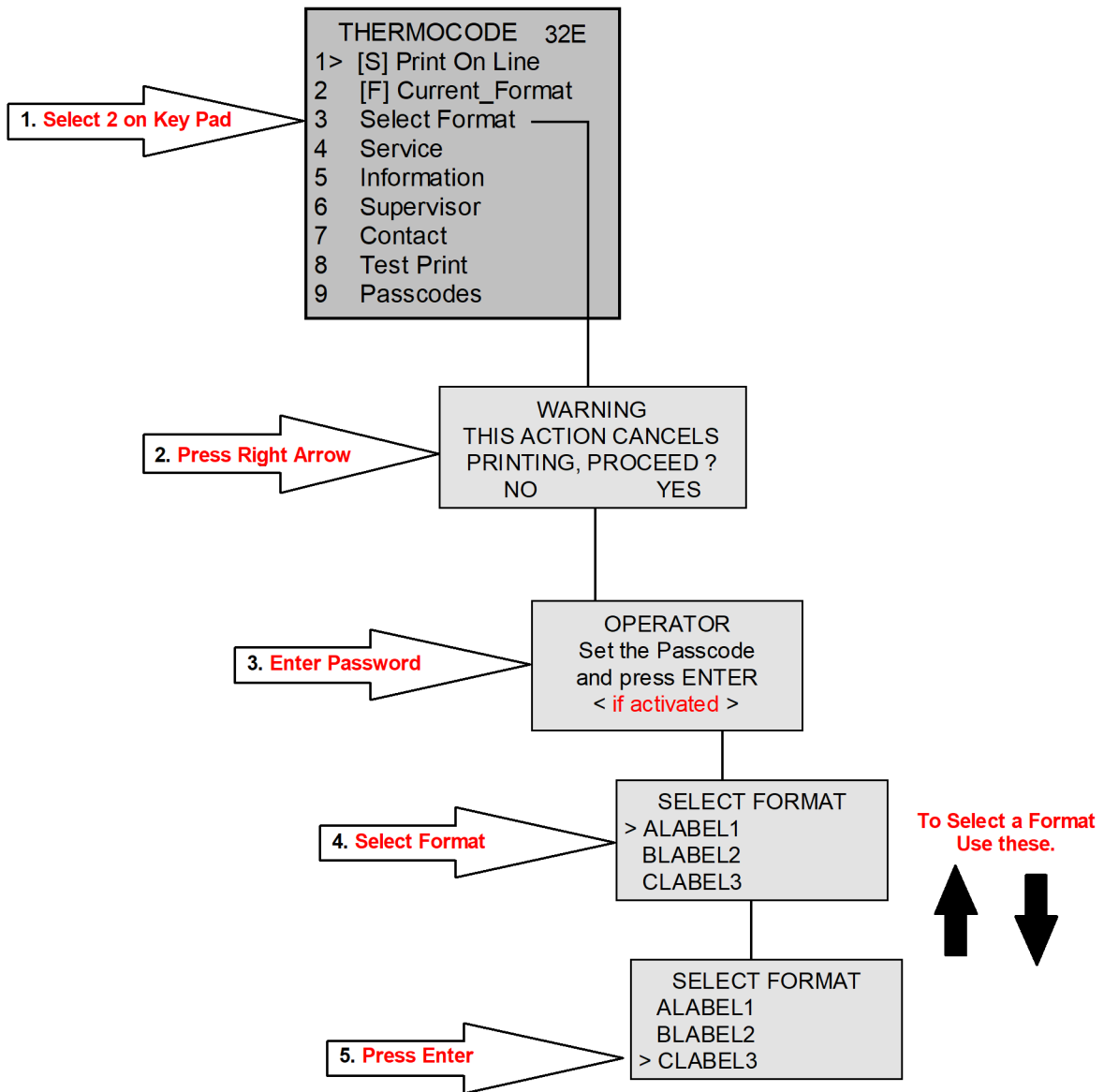

Left Arrow A to Z ←

SELECT FORMAT  
> ALABEL1  
BLABEL2  
CLABEL3

SELECT FORMAT  
> 1\_LABEL  
2\_LABEL  
3\_LABEL

→ Right Arrow Z to A

SELECT FORMAT  
>CLABEL3  
BLABEL2  
ALABEL1

SELECT FORMAT  
> 3\_LABEL  
2\_LABEL  
1\_LABEL

To Select a Format  
Use these.  
↑ ↓

**EDITING TEXT FIELDS**

**Editing Text Fields**

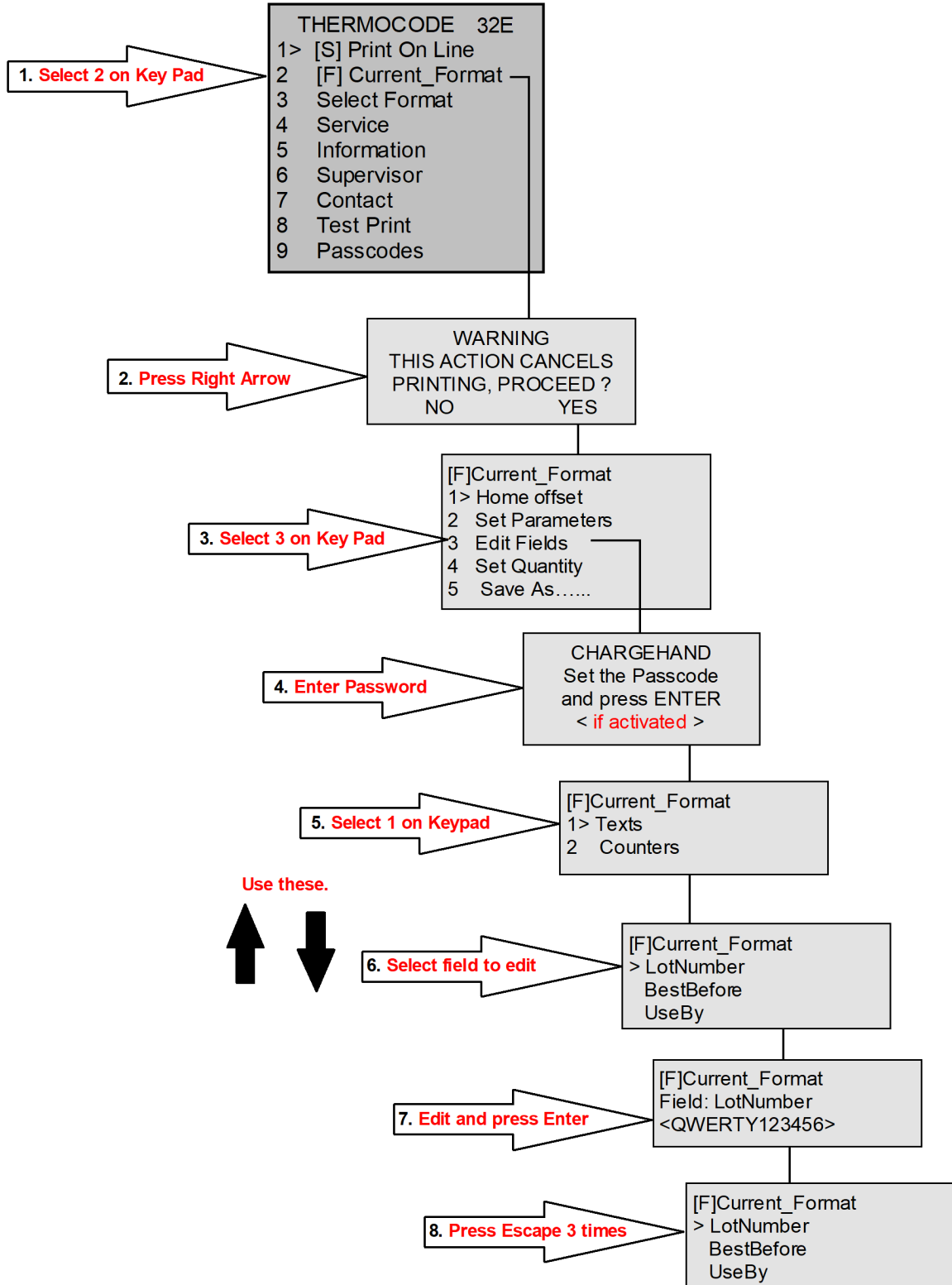



**Making Test Prints**

**MAKING TEST PRINTS**

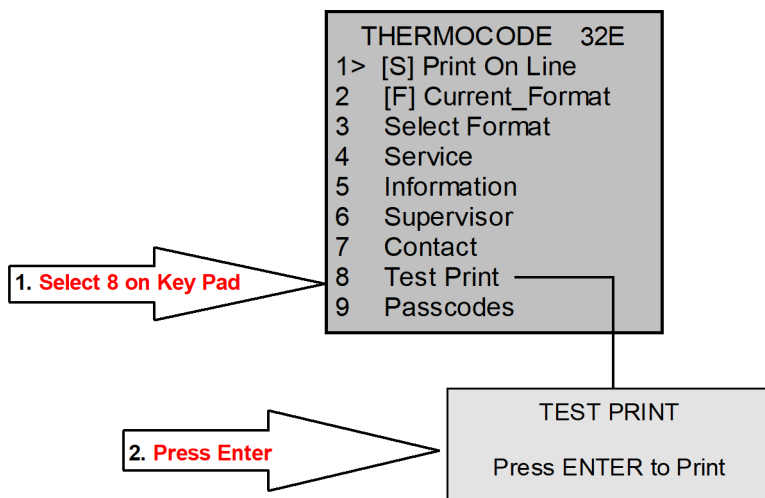

**Holding down the ENTER key will allow continual Printing**

**Information screen**

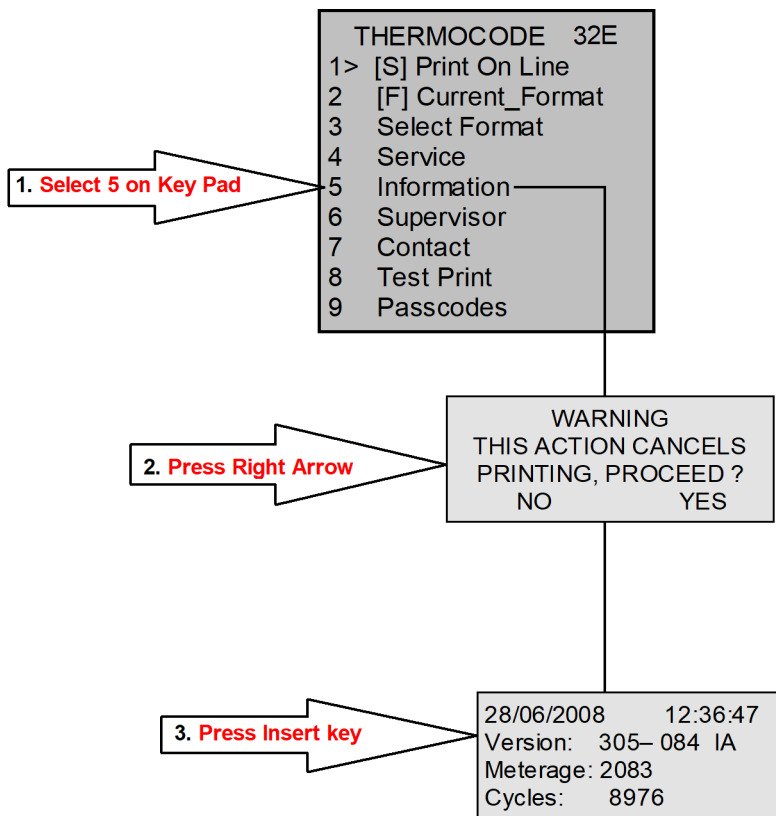

**Thermal Ribbon Specifications**

Printer	A (width)	B (max)	C	Core
32E	35mm	65mm	25.4mm	Cardboard

Silicone based “Back Coating” Outside (Low coefficient of friction:  $K_d < 0.2$ )

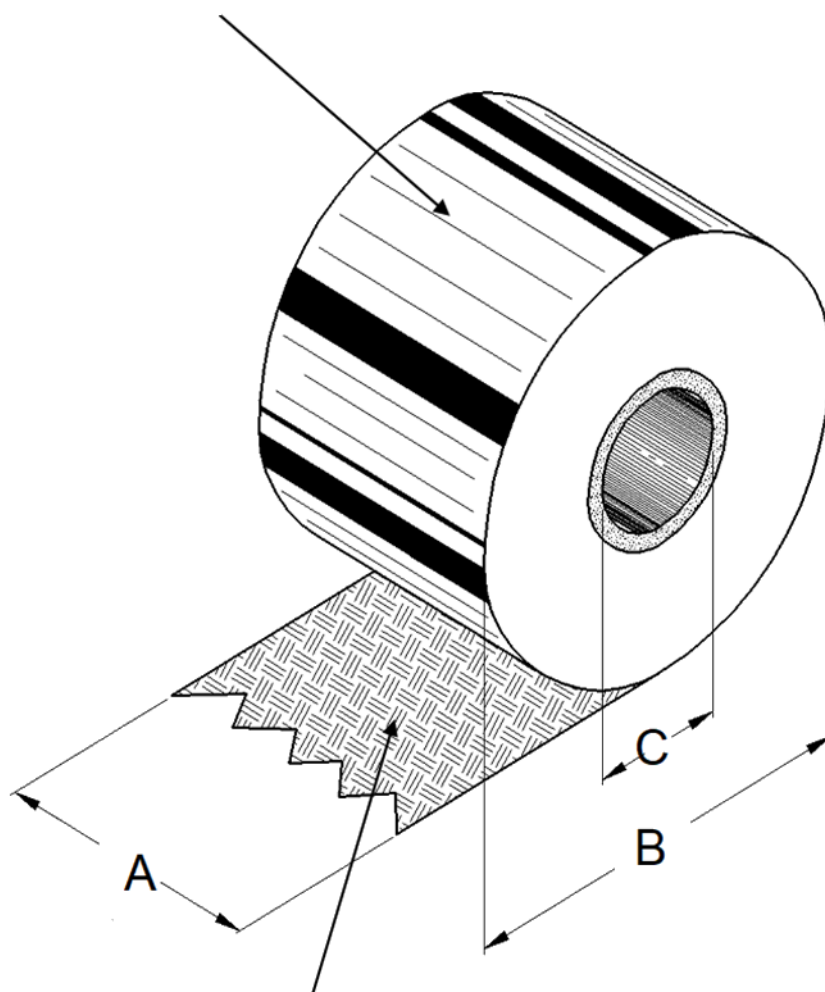

Wax / Resin pigment inside wound

No leaders or trailers required on foil.

Open Date Equipment stocks several grades, sizes and colours of Thermal Transfer Ribbon.

Please call one of our sales office's for further details or visit us at

[www.opendate.com](http://www.opendate.com)

### Ribbon Threading Diagram

#### Fitting A New Ribbon

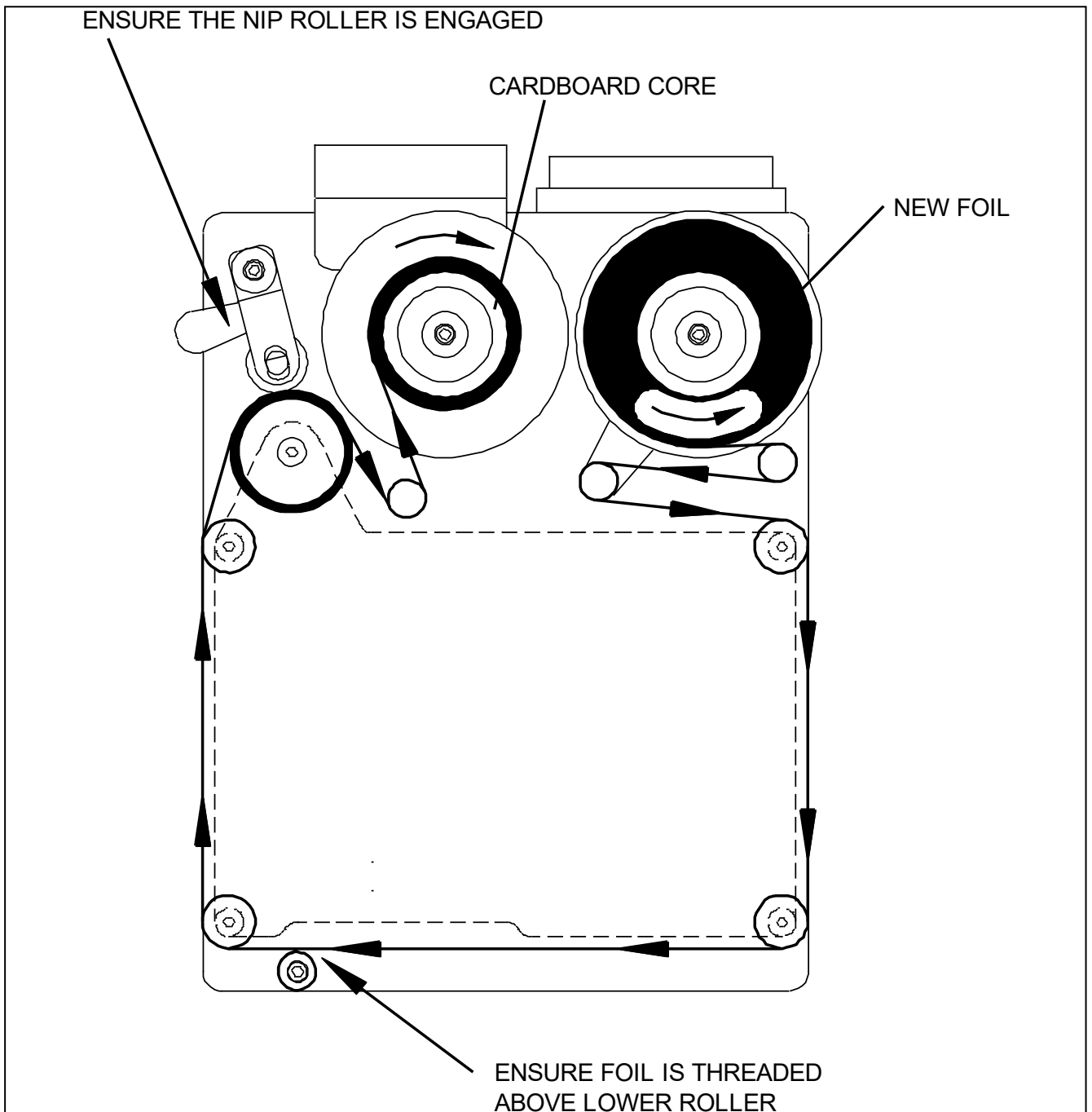

### Daily Maintenance

1. To simplify cleaning procedures, you may have to remove the printer from the frame.
2. Remove the thermal transfer ribbon from the printer.
3. Clean all fixed rods and rollers using Isopropanol cleaning fluid and a lint free cloth.
4. Clean the printhead along the full length, where the heating elements are shown.
5. Clean the rubber drive roller and nip roller.

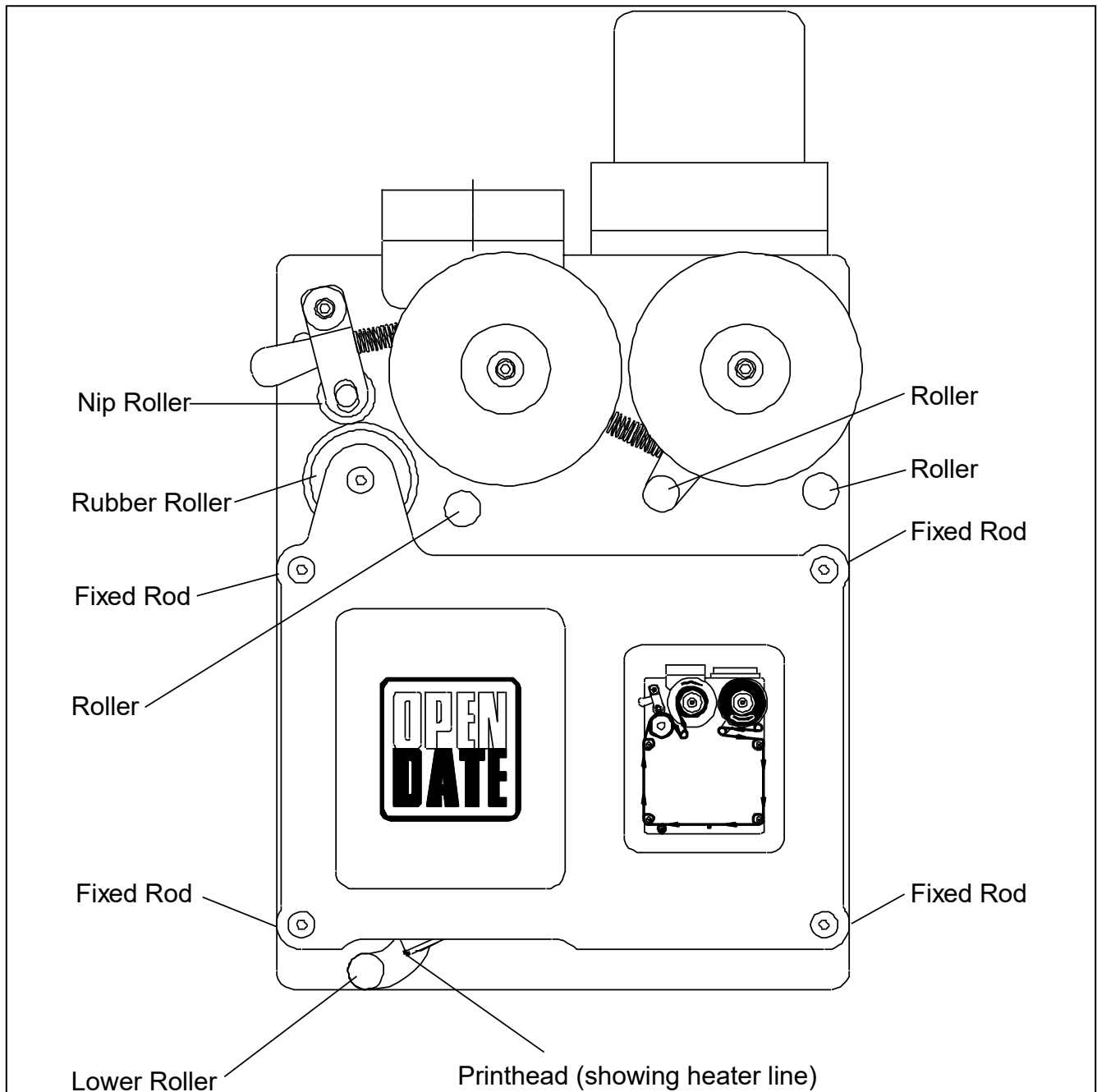

## Fault Finding

### Ribbon Indexing Not Enough (Overlapping Prints)

**Q. Cardboard core does not fit the rewind spool correctly, or is missing?**

A. Fit correct cardboard core, ensure it is located on the spring clips correctly.

**Q. Foil not attached to cardboard core correctly?**

A. Use adhesive tape to attach the ribbon to the cardboard core, and wind on a few turns.

**Q. Rollers, Printhead rollers or Printhead assembly are dirty, through build up of wax/resin residue?**

A. Clean rollers and Printhead as described in maintenance section.

**Q. Brake belt is damaged, worn or dirty?**

A. Renew brake belt.

**Q. Tension arm spring tension on brake belt not set correctly?**

A. Adjust belt brake correctly, when functioning correctly the tension arm should be about 6mm from the stop pin.

### Ribbon Indexing Excessive

**Q. The format design has a space before printing any characters?**

A. Change the format design so there is only 1mm from the "X" datum to the first characters to be printed.

**Q. Ribbon may be sticking to Substrate being printed and being pulled along?**

A. Adjust the Printhead position from the substrate, possibly the clearance is insufficient and the foil is being indexed along with the substrate. Service Engineer may be required.

### Ribbon Breaking or Perforated

**Q. Rollers or Printhead assembly are dirty through build up of wax/resin residue?**

A. Clean rollers and Printhead as described in maintenance section.

**Q. Ribbon may be sticking to substrate being printed and being pulled along?**

A. Adjust the Printhead position from the substrate, possibly the clearance is insufficient and the foil is being indexed along with the substrate. Service Engineer may be required.

**Q. Temperature "BURN" values may be set to high for the substrate being printed?**

A. Reduce "BURN" values of format to achieve acceptable print quality.

## **Fault Finding (Continued)**

### **Ribbon Tracking to One Side**

- Q. Rollers, Printhead rollers or Printhead Assembly are dirty, through build up of wax/resin residue?**
- A. Clean rollers and Printhead as described in maintenance section.
- Q. Ribbon may be sticking to substrate being printed and being pulled to one side?**
- A. Adjust the Printhead height from the substrate. Possibly the clearance is insufficient and the ribbon is being indexed along with the substrate. Service Engineer may be required.

### **Print Quality Problems**

- Q. Print not consistent over printed area?**
- A. Ribbon not compatible with substrate.
- Q. Temperature, burn settings too low?**
- A. Low printing temperatures can give the effect of the edges of characters appearing faint or ragged.
- Q. Damaged or dirty print base rubber?**
- A. Clean and check for any imperfections. Normal Thermocode Series print bases are 45-50 shore hardness rubber, which is bonded to an aluminium backing sheet and then ground. Flatness of this pad is very important, on some labelling machines if the backing web is not aligned correctly it will cut into the print base or actually miss-shape it due to the tension of the backing web.
- Q. Printer not correctly mounted in frame, printer frame not manufactured to correct dimensions, clearance under printer excessive?**
- A. See Standard Frame measurements drawings at the end of this manual.
- Q. Printhead dirty or pixels burnt out?**
- A. Clean Printhead and test print on plain fax paper to confirm Printhead condition.
- Q. Ribbon ink coating inconsistent?**
- A. Check and replace ribbon.

### **Clearing Printer Errors**

All errors that occur within the printer are shown as “**Error**” on the status line of the Mini-Terminal display. To view the actual error press No.1 or the Enter key of the keypad. Errors are shown as text messages along with a numerical number which must be noted if you are requesting a Service visit or assistance.

Once errors have been viewed they can then be cleared, page up to the top of the screen and press “Enter” when the cursor is next to the option “Clear errors”.

Clearing errors can have two consequences, if the errors are mechanical the error is cleared and the format is retained in the image memory. If the error is a format design problem, as the error is cleared the format will be removed from the image memory.

The only way to correct format errors is to redesign the format this cannot be corrected by adjusting parameters within the Mini-Terminal parameters.

**Thermocode Intermittent Printer Diagnostics - sheet 1**

FAULT DESCRIPTION	REMEDY / ACTION
Flashing cursor on mini-terminal screen.	<ol style="list-style-type: none"> <li>1. Open the nip roller and then close it.</li> <li>2. Replace display curly cable.</li> <li>3. Replace display.</li> <li>4. Replace processor board and re-program.</li> </ol>
Error on start up (boot up). X or Y overflow.	<p>If the mini-display shows 32 with a "0" after it instead of "E"</p> <ol style="list-style-type: none"> <li>1. Check 10 way ribbon connections, each end.</li> <li>2. Contact your supplier, to fix the Printhead problem.</li> </ol>
Printhead temperature. (Head Cold Fault)	Change the wider ribbon cable between the printhead and processor board.
No display on the mini-terminal.	Check the F4 fuse within power supply. See page 8.
Printhead LED, not working. (Power Supply)	Check the F3 fuse within power supply (see page 8).
Printing wavy barcodes.	<ol style="list-style-type: none"> <li>1. Brake arm loose on brake on brake lever.</li> <li>2. Retaining washer loose or missing from foil rollers.</li> <li>3. Increase the Print height above the substrate.</li> </ol>
Ribbon tracking (movement to one side)	<ol style="list-style-type: none"> <li>1. Check brake is not set to tight.</li> <li>2. Check brake arm is not loose.</li> <li>3. Check any foil guides are not loose or bent.</li> <li>4. Check Printhead is levelling correctly.</li> </ol>
Broken ribbon sensor.	Check the brake arm is not loose, and passes through the sensor correctly.

**Thermocode Intermittent Printer Diagnostics - sheet 2**

FAULT DESCRIPTION	REMEDY / ACTION
No power to printer / No voltage to power supply	<ol style="list-style-type: none"> <li>1. Check fuses in mains plug and power supply.</li> <li>2. Check supply voltage is at source.</li> <li>3. Check all the fuses in power supply.</li> <li>4. Check all electrical connections are correct.</li> </ol>
Ribbon broken.	<ol style="list-style-type: none"> <li>1. Replace ribbon.</li> <li>2. Check brake tension on cassette.</li> <li>3. Replace or repair thermal ribbon.</li> </ol>
Low ribbon warning.	Replace thermal ribbon on printer, ensure that you press the "yes" key on the mini-terminal after engaging the nip roller, to reset the foil counter.
Count completed.	<ol style="list-style-type: none"> <li>1. Select another format.</li> <li>2. Edit quantity via mini-terminal display</li> </ol>
No format name displayed on screen.	<ol style="list-style-type: none"> <li>1. Format has been de-selected.</li> <li>2. Select a new format.</li> </ol>
No font loaded to printer, for format selected.	<ol style="list-style-type: none"> <li>1. Load the font to printer and select the format again.</li> <li>2. Load a different format that has printer fonts.</li> <li>3. Check which fonts have been loaded to printer, by interrogating with the "Codesoft" software</li> </ol>
Print on line, awaiting print signal.	Normal condition
Pressure switch fault.	<ol style="list-style-type: none"> <li>1. Check the mounting frame is not open.</li> <li>2. Check the gap between printer and print base.</li> <li>3. Check sensor assembly has not come loose.</li> <li>4. Check wire crimps and connections.</li> <li>5. Check LED on sensor activates correctly.</li> <li>6. Check print base rubber is not damaged or missing.</li> <li>7. Check pressure setting within format parameters.</li> </ol>
Vertical home sensor fault.	<ol style="list-style-type: none"> <li>1. Check sensor assembly has not come loose.</li> <li>2. Check wire crimps and connections.</li> <li>3. Check LED on sensor activates correctly.</li> </ol>
Printhead Thermistor fault / disconnected	<ol style="list-style-type: none"> <li>1. Check ribbon cables are fitted correctly to printhead and interconnect PCB.</li> <li>2. Faulty printhead, replace.</li> </ol>



## Error Messages

This file contains a list of error texts and their associated error numbers. The error numbers are displayed **after** the error text, along with the source number, with the exception of the two shown below.

Error Message	Reason	Corrective Measures
Run Program	Firmware corruption	Switch the printer off. Then Reload the firmware.
<b>No Program Loaded</b>	Disconnection on communications lead, when down loading the Firmware.  Sending fonts or formats, whilst booting up the printer.	Press the enter key, reset the Baud rate, reset the RTC. Press accept. Switch the printer off. Then Reload the firmware.

Example: **Pressure not seen 21, 2266**

This is error number **21**, on line number **2266** of the source code file. This line number is only of use to the developers, but is worth recording along with the version of firmware.

Error Number	Error Message	Reason	Corrective Measures
<b>11</b>	<b>Serial port fail</b>	Problem with hardware.	Check cables & connections, if the cables are ok replace the Processor Board.
<b>12</b>	<b>SPY chip fail</b>	1. Failure in writing to the Spy chip from the boards. 2. The Ribbon Cable could be faulty.	1 & 2. Re program or change the Spy Chip Board. If you still have the same Fault Change the Ribbon cable. <b>(14 Days notice See note 1 on page 38)</b>
<b>13</b>	<b>SPY buff fail</b>	Wrong version of Software.	Reprogram or change the spy chip board. If you have the same fault change the ribbon cable.
<b>14</b>	<b>SPY param fail</b>	Wrong version of Software.	Reprogram or change the spy chip board. If you have the same fault change the ribbon cable.
<b>15</b>	<b>RTC fail</b>	Faulty real time clock.	Check the battery for 3.6v. Change the processor board.
<b>16</b>	<b>DAS can't format</b>	Problem with memory on processor card.	Change the processor board.
<b>17</b>	<b>Head overheated</b>	1. Thermistor failed on Printhead. 2. The Ribbon cable could be faulty.	1 & 2. Change the printhead. If you still have the same fault change the ribbon cable then refit the original Print head
<b>18</b>	<b>Head Cold</b>	1. Thermistor failed on Printhead. 2. The Ribbon cable could be faulty.	1 & 2. Change the printhead. If you have the same fault change the ribbon cable then refit the original printhead.
<b>19</b>	<b>Too fast 1</b>	Web speed too fast for printer.	Reduce web speed.
<b>20</b>	<b>Too fast 2</b>	Web speed too fast for printer.	Reduce web Speed.
<b>21</b>	<b>Pressure not seen</b>	1. Pressure sensor Failed or dirty. 2. Frame open or Print pad missing 3. Incorrect Motor steps to the Print Pad. Occurs on Format Download & when printing. 4. Low voltage. Under 5 VDC to the Printer.	1. Clean or replace the sensor. 2. Switch the Printer off. Close the Frame or replace the Print Pad. Reboot the Printer. 3. Clear the error. Carry out some test prints. 4. Check the voltage and adjust to 5.1 volts. Fault 155 "No press confirmed" will also be shown. Carry out the above checks, when both faults are shown.
<b>22</b>	<b>End sensor fail</b>	The Print head has not seen the end sensor	1. Clean the sensor or change if failed. 2. Check the ribbon cables are not fouling the guard of the Printer. Display may read as a 107S when the Printer is actually 107M.

**Note:-** *The first error displayed by the mini terminal is the fault. Any other faults shown on the display may be generated because of the fault displayed.*

Error Number	Error Message	Reason	Corrective Measures
23	Serial port over-run	Problem of serial port hand-shake.	Check your Com port setting. Try new serial port cable. If that makes no difference change the processor boards.
24	Serial buffer over-run	Problem of serial port hand-shake.	Check your Com port setting. Try new serial port cable. If that makes no difference change the processor boards.
25	Start sensor too close.	The start sensor is too close to the printhead	Move the start sensor way from the printhead.
26	Sys param unknown	Requested or sent a unknown system variable	Request or send the correct variable.
27	Relay delay out of range	Problem with variable SYSREDEL	Check the setting in the mini terminal. Service menu no 6, menu no 3 Delay (Inhib delay)
28	Format param unknown	Format parameters incorrectly entered in the format.	Correct the parameters. This fault can only be created using DOS.
29	Sys string long	System Variable string has an incorrect entry. E.g. 13 months instead of 12 entered in SYSMON etc.	Correct the system variable and resend to the printer.
30	List type unknown	Z? Requesting a nonexistent system variable	Clear the error. Enter the correct request code.
31	Delete type unknown	Deleting an unknown request.	Incorrect escape code used when using the delete command.
32	List file unknown	Requesting a non-existent format or font etc.	Clear the error. Request the correct format or font etc.
33	Delete file unknown	Deleting an unknown format file.	Typing error or the format, font etc is not in the printer.
34	Bad line	1. Communication lead faulty. 2. Codesoft has been networked	1. Check the communications lead is plugged in to the computer & printer. Check the lead for damage or bad connections. 2. If not networked, check Codesoft is not set to Network in the Advanced menu.
35	Bad Format Line	Format information Incorrect	Correct the format design.
36	Format line too long	1. Text line too long maximum of 149 character & spaces. 2. The text box used in Codesoft is larger than the required text. With no carriage return. 3. Codesoft, Word wrap has been checked. 4. Baud rate incorrect	1. Reduce the text line. 2. Reduce the text box to the size of the text length. 3. Uncheck the word wrap in Properties & Paragraph. 4. Check the Baud rate within Codesoft.
37	Local graphic error	Problem with local graphic in a format.	Re-load format, or check graphic.
38	Graphic file missing	Format sent to the printer without the graphic file. Global graphic has been deleted from the Printer.	In Codesoft Printer settings, General, Reload image at next print job should be checked (box ticked). Correct the format design & resend to the printer.
39	Too many local graphics	Too many local graphics designed within the format.	Reduce the number of graphics within the format design.
40	Too many graphics	Too many local and global graphics loaded to the printer	Reduce the number of global graphics.
41	Can't update format not selected	The format has not been selected for Printing.	Select the format you wish to send modified data only to.
42	Box too narrow for line width	Box design incorrect	Correct the format design. This fault can only be created in DOS.
43	Box too low for line height	Box design incorrect	Correct the format design. This fault can only be created in DOS.

**Note:-** *The first error displayed by the mini terminal is the fault. Any other faults shown on the display may be generated because of the fault displayed.*

Error Number	Error Message	Reason	Corrective Measures
44	Line/ box too wide	Box design incorrect	Correct the format design. This fault can only be created in DOS.
45	Rotation out of range	Incorrect rotation set in the format. Should be 0,1,2 or 3	Correct the format with correct rotation. The fault can only be created using DOS.
46	Scale factor wrong	Graphic Scaling factor incorrect should be 0,1 or 2	Correct the format design.
47	Bar lines overflow	Incorrect barcode design.	Correct the barcode design. The fault can only be created in DOS.
48	Bad bar style	Selected a non-supported barcode type.	Check the type of barcode required. The fault can only be created in DOS.
49	Bad bar width	Bar width larger than 5 or less than 2.	Bar width maximum 5, minimum 2. This fault can only be created in DOS.
50	Bad bar ratio	Ratio within the barcode format design incorrect. Available Ratios are 0 =3,1= 2.5 & 2= 2	Correct the format design. This fault can only be created in DOS.
51	Bad bar human	Human readable is larger than 1	Human readable maximum 1, minimum 0. This fault can only be created in Dos.
52	Bad bar csum	Check Digit value larger than 1	Check digit maximum 1, minimum 0. The fault can only be created in DOS.
53	Bad bar speed	Incorrect Speed flag. Should be Zero	Correct the Barcode design. This fault can only be created in Dos.
54	Bad bar data	Barcode data to many or few digits for the barcode type. Check type of barcode, whether numerical, alphabetical or both.	Change the number of digits to suit the Barcode type. Check the style of barcode and the data needed.
55	Graphic To Wide	Graphic too wide for the printer. Graphic file corrupted?	Resize or replace the graphic
56	X underflow	Format design is outside of the print area on the left side of the "X" axis.	Move the format design to be within the print area.
57	X overflow	Format design is outside of the print area on the right side of the "X" axis.	Move the format design to be within the print area.
58	Y underflow	Format design is outside of the Print area at the top of the page on the "Y" axis.	Move the format design to be within the print area.
59	Y overflow	Format design is outside the print area at the bottom of the page on the "Y" axis.	Move the format design to be within the print area.
60	Timeout in Binary	1. Incorrect Baud rate set 2. Noise on the communication lead 3. Incorrect Network number set. (Network printers only)	1. Check the Baud rate 2. Check the communication lead. 3. Check the Network number.
61	Timeout in format	1. Information in the format design missing or incorrect 2. Network number set in the printer but not in Codesoft.	1. Correct the format design. Other error generated during the download of the format or fonts. 2. Set the printer Network number to zero if no Network then reboot the printer. If networked, set network number in Codesoft.

Note:- *X and Y overflows. Do not use Arial Black type font. The Codesoft WYSIWYG is incorrect when using this.*

Note:- *The first error displayed by the mini terminal is the fault. Any other faults shown on the display may be generated because of the fault displayed.*

Error Number	Error Message	Reason	Corrective Measures
62	Format not found	Requested a format not downloaded to the Printer.	Requested the wrong format name or the format is not loaded to the printer.
63	Erasing font in use	Deleting a font when used in the current format.	Stop printing, delete the font. Re-select a format.
64	Reverse field wrong	Reverse image text should be 0 or 1 (not supported)	Correct the field.
65	Proportional field wrong	Incorrect proportional field. Value = 0 or 1	Correct the value. This fault can only be created in DOS.
66	Text field overflow	Maximum text in variable = 0 to 59	Reduce text length in variable to less than 60.
67	Text lines overflow	Too many text lines within the designed format	Reduce the amount of text. Maximum of 120 lines.
68	Text fields overflow	Too many text fields within the format.	Reduce text fields in format to be below 150.
69	Too many counters	Format design has too many counters. Maximum of 20 counter fields.	Reduce the number of counter fields with in the format design.
70	Too many Variables	Too many variables within the format.	Reduce the number of variables.
71	Missing variable	The variable has not loaded with the format	Correct the format design
72	Variable out of limit	Variable field with high and low limits	Correct the variable field. This fault can only be created in DOS.
73	Global counter too wide for field	Incorrect counter field design	Correct the counter field. Enter a padding character in the counter field. Found in "Output" Enter "0" (Zero).
74	Local counter too wide for field	Incorrect counter field design	Correct the counter field. Enter a padding character in the counter field. Found in "Output" Enter "0" (Zero).
75	Font missing	The Font required is not loaded to the printer	Load the appropriate font to the printer.
76	Font size unavailable	A Bitmap font (SFP) has been downloaded. The Format design has an incorrect point size.	Correct the format design or load the correct Bitmap font.
77	Font file problem	Bitmap font loaded to the printer without a font size.	Delete the font, correct your font file then reload the font to the printer. Enter the font size. This fault can only be created using DOS files to download fonts.
78	Font code problem	Corrupted font file.	Delete and then replace the corrupted font.
79	Time out of range	Incorrect time form sent to the printer. e.g. 2530	Correct the field.
80	Date out of range	Incorrect date form sent to the printer. e.g. 321002	Correct the field.
81	Can't update variable	Variable has not been designed in the format or is missing.	Correct the format design.
82	Global variable unknown	The Global variable has not been loaded to the printer or has been deleted.	Resend the global variable to the printer.
83	Daysave error	Incorrect information entered in the daylight save field.	Correct the daylight saving field.
84	Sys param out of range	Changing a system parameter with a value out range.	Correct the parameters with in your format design The fault can only be created using Termode or Service.
85	Too Many Horizontal Steps	1. The Home offset set too high for the size of Printer. 2. The printer has not seen the end or the sensor has failed. The one to the right of the printer.	1. Reduce the home offset. 2. Check the sensor is clean & working and the Ribbon cables are not fouling the guard of the printer. Top line may read as a 107S when the printer is a 107M,

**Note:-** The first error displayed by the mini terminal is the fault. Any other faults shown on the display may be generated because of the fault displayed.

Error Number	Error Message	Reason	Corrective Measures
86	Format has no image	The Format has not been generated for the Image memory when other Faults have occurred.	Rectify the faults within the format.
87	Line with no network number	Format sent to the wrong network number.	Check the network numbers are correct.
88	Line with unwanted network number	Network number selected in Codesoft. Printer has no network number set.	Printer settings, then Advanced. Uncheck the "Network" box. Then click OK.
89	Burn file corrupt	Bad data written in the burn file before being compiled, or corrupted on send.	Check & correct the burn file
90	Burn file to long	Incorrect burn file design.	Check & correct the burn file.
91	Burn duty too high	1. The burn duty in the format has been set too high. 2. The burn duty in set parameters is too high. 3. The burn duty is close to or set on the upper limit and the room or head temperature has raised.	1. Reduce the burn duty within the format and resend to the printer. Or change with in the mini terminal.  1. 2 & 3. Reduce the burn duty within set parameters.
92	H table overrun	Internal software error.	Report, with format to Open Date UK
93	R table overrun	Internal software error.	Report, with format to Open Date UK
94	V table overrun	Internal software error.	Report, with format to Open Date UK
95	Bad case	Internal software error.	Report, with format to Open Date UK
96	Can't write parameter Update	Internal software error.	Try INEW, then report, with format to supplier
97	Can't read parameter Update	Internal software error.	Try INEW, then report, with format to supplier
98	Bad file copy	Internal software error.	Try INEW, then report, with format to supplier
99	Can't open temp FMS	Internal software error.	Try INEW, then report, with format to supplier
100	Can't open parameter file	Internal software error.	Try INEW, then report, with format to supplier
101	Can't open format file	Internal software error.	Try INEW, then report, with format to supplier
102	Get Character fail	Internal software error.	Try INEW, then report, with format to supplier
103	CM_ALLOCATE fail	Internal software error.	Try INEW, then report, with format to supplier
104	FM_ALLOCATE fail	Internal software error.	Try INEW, then report, with format to supplier
105	Write to read only store	Internal software error.	Try INEW, then report, with format to supplier
106	Read only store missing	Internal software error.	Try INEW. Try reloading .HEX file, report, with format to Open Date UK
107	ASY_STAT bad	Internal software error.	Report, with format to supplier
108	Print On Line	Printer waiting a print signal.	(No error)
109	Loading Format	Format being loaded to the image memory.	(No error)
110	Creating Image	Image being created within the image memory.	(No error)
111	Printing	Only seen when printing large formats at low speed.	(No error)

**Note:-** *The first error displayed by the mini terminal is the fault. Any other faults shown on the display may be generated because of the fault displayed.*

Error Number	Error Message	Reason	Corrective Measures
112	Cassette Off	Cassette is off or possible sensor fault.	If the cassette is on the printer but the cassette off message appears check the cassette release & the cassette sensor.
113	Ribbon break	Burn too high, ribbon settings incorrect	Reduce the burn. Check the ribbon settings. Check the cassette brake arm tension.
114	Initialising	Printer boot up sequence.	(No error)
115	Find pre print	Pre print height. Default 1mm. User selectable	Service Menu, No 3, Datum. 1 to 9mm (No error)
116	Parking	Printer boot up sequence & after replacing the Cassette.	(No error)
117	Error	You have an error	Press the enter key, scroll down to the last fault in the list.
118	Printing paused	Operator selected printing paused.	Deselect paused printing
119	Count Completed	Selected number of printer counts completed.	Reset the counter field. Will occur after one print if infinite print is not selected within Codesoft.
120	Ribbon Low	The ribbon is low or incorrect ribbon settings	Replace the ribbon. Check the ribbon settings 50, 300 or 500mm
121	Print Off Line	No format loaded to the printer image memories	Select or download a format
122	Prints too close for high speed	The printer was still printing the last image when distance delay expired.	Try decreasing the distance from the print registration sensor to the printer.
123	Trigger whilst printing	A print signal sent to the printer when printing.	Try decreasing, the distance from the print registration sensor to the printer. Check the shaft encoder. (See fault 125)
124	Trigger no profile	Software error.	Try reloading the format. Report to supplier.
125	Too many triggers	Too many print signals sent to the printer.	Check the encoder for mechanical faults, encoder drive wheel slip, mounting brackets etc. Check the electrical connections. Reduce the distance of sensor from printer.
126	Too many shift codes	Too many shift codes entered in the format design	Reduce the number of shift codes maximum of 24
127	Home offset too big	Home offset too large within the format design	Reduce the home offset & resend the format to the printer.
128	Bar too large	The barcode is too large for the printer to generate	Try reducing the barcode bar width
129	Can't open fixed config	Major internal software error.	Try reloading the firmware. Contact supplier.
130	Can't open new config	Major internal software error.	Try reloading the firmware. Contact supplier.
131	Failed config read	Major internal software error.	Try reloading the firmware. Contact supplier.
132	Command not supported	Major internal software error.	Try reloading the firmware. Contact supplier.
133	Can't load file	Major internal software error.	Try reloading the firmware. Contact supplier.
134	Nip Roller open	32E Nip roller is open (53E & 32E only)	Close the nip roller. If you cannot clear the error check the nip roller sensor & the 5 volts.
135	Not Used.		
136	Trigger whilst Printing	A print signal was sent to the printer whilst it was updating the variable fields.	Try decreasing, the distance from the print registration sensor to the printer. Check the shaft encoder. (See fault 125)
137	Disk Full	Too many formats loaded to the printer (Printer RAM Disk)	Delete some formats from the printer memory.
138	SPY chip fail	Reminder message	After 14 days the printer will stop printing. Change the print head. See note 1 on page 38.

**Note:-** *The first error displayed by the mini terminal is the fault. Any other faults shown on the display may be generated because of the fault displayed.*

Error Number	Error Message	Reason	Corrective Measures
139	Print Before image update	The printer image memory has not updated the variable information sent to the printer, usually from a data base (UPMODE 3)	Ensure the update is sequenced correctly.
140	Day/Month offset wrong	Day offset entered with a month offset	Correct the formats design. Remove the day offset if a month offset is required. You cannot use both types of offset at once.
141	Comm output time-out	Printer port timed out.	Clear the error. Resend the data if required. If the printer has locked up reboot it.
142	Printer Locked	Variable CFRPT2 has been set to 2.	You cannot send any formats or fonts to printer when locked. Clear the error, unlock the printer then resend the format or font.
143	IP_SMALL_BUFF TCP/IP	Internal error	Try reloading the firmware. Contact supplier
144	LOCKED	Incorrect use of CFRPT2	Correct the way you are using of CFRPT2.
145	Serial Line overflow	Using the "OY" command more than once. Returns variable data to a computer, using UPMOD 4 & UPMOD 5	Correct the format design and resend too the printer.
146	Variable type unknown	Trying to create an unrecognisable variable (Not a counter or date)	Recreate the variable the correct way.
147	Var File	Trying to use a file type variable and cannot open the file with the data	Correct the variable file and resend to the printer
148	Comtrig invalid	Invalid field entry in the variable SYSCOMTRIG	Correct the data entered in the SYSCOMTRIG field.
149	Comtrig loop too small	The distance between the formats is too small.	Increase the distance between the prints in SYSCOMTRIG
150	Trggers /image don't match	SYSCOMTRIG is incorrect and does not match the formats	Correct the SYSCOMTRIG or the number of formats required for printing.
151	Using COMTRIG without SYSILEN	No Value set in SYSILEN	Send the length of the largest image to be printed. The value is in millimeters.
152	Multi Image select invalid	Valid Image memories are W0X, W1X, W2X. X being the image number	Two or more image memory numbers are the same. Correct the image memory number. See document Multi Printing for Continuous & Intermittent Printers.
153	No image selected with SYSILEN	SYSILEN has no image memory address.	The SYSILEN has not been allocated an image memory address. (ILEN ,00,01,02 etc)
154	COHDEL to big	COHDEL is set to large in relation to the print height & pressure	Reduce COHDEL then clear the error. Max value is dependent on print head height. This is measured in steps.
155	No Press confirmed	No pressure confirmed. Internal software error.	Pressure not seen in the internal software loop when starting to print. To indicate the difference between a pressure or pressure sensor fault.
156	Bad PCX	PCX graphic error	Change or modify the graphic and resend to the printer.
157	Counter field CINIT	Counter fields not recognised after installing new firmware.	CINIT the printer then reload the fonts and formats
158	Speed to slow	Variable type MCPSSLOW is set to 1	The parent machine speed is the same as or slower then value set in MCSPEED

**Note:-** *The first error displayed by the mini terminal is the fault. Any other faults shown on the display may be generated because of the fault displayed.*

Error Number	Error Message	Reason	Corrective Measures
5007 5008 5009 5010	Open Date Loading Error	1.Noise down the communication lead i.e. sending a format or font when the printer is booting up. 2.Booting your computer & printer at the same time	1.Do not send to the printer except firmware when booting up. Reboot the Printer.  2.Do not boot the computer and printer together. Disconnect the comms lead from the printer and reboot it
5011	Loading Error	Baud rate incorrect	Check baud rate is same on computer and printer.

**Note:-** *The first error displayed by the mini terminal is the fault. Any other faults shown on the display may be generated because of the fault displayed.*

**Note 1:-** **Spy chip fail.** When this message first appears this will read **"SPY chip fail 12, 34,14"**  
This will allow the printer to run for 14 days decrementing each day to 0.  
On the 14<sup>th</sup> day the message will read **"SPY chip fail 12, 2233, 0"**

An error message will be displayed daily at approximately midday until the fourteen days have expired or the printhead has been changed.



## Print Speed & Burn Modifications within Software

The modifications that have been included within the software automatically adjust all the printhead CONT lines percentage values for different printing speeds.

### Software Advantages

- Longer Printhead Life (lower initial power settings).
- Improved Quality of Print (even density of image).
- Automatic burn adjustment at different speeds (speed compensation).

### Automatic Speed Compensation

The software allows the user to change print speed of a format without the need to adjust the burn values.

The speed compensation chart below gives a guide as to the maximum and proposed values for printing onto various materials using different thermal transfer ribbons.

### Speed Compensation Chart

Use the values below to configure the print format ready for printing. The values are only a general guide and are likely to need changing to suit the material to be printed.

Once the image is correct, the print speed can be adjusted to suit the application. Burn values will be automatically

Description	Value
Print speed	100mm/sec
Maximum burn value (nominal)	303μsec
Polyethylene type material (wax/resin foil)	180μsec
Polyester type material (wax/resin foil)	200μsec
Label type material (wax/resin foil)	240μsec
Polyethylene type material (resin foil)	200μsec
Polyester type material (resin foil)	220μsec
Label type material (resin foil)	260μsec
Thermal label (direct thermal)	200μsec

### Thermocode 32E Printer Dimensions

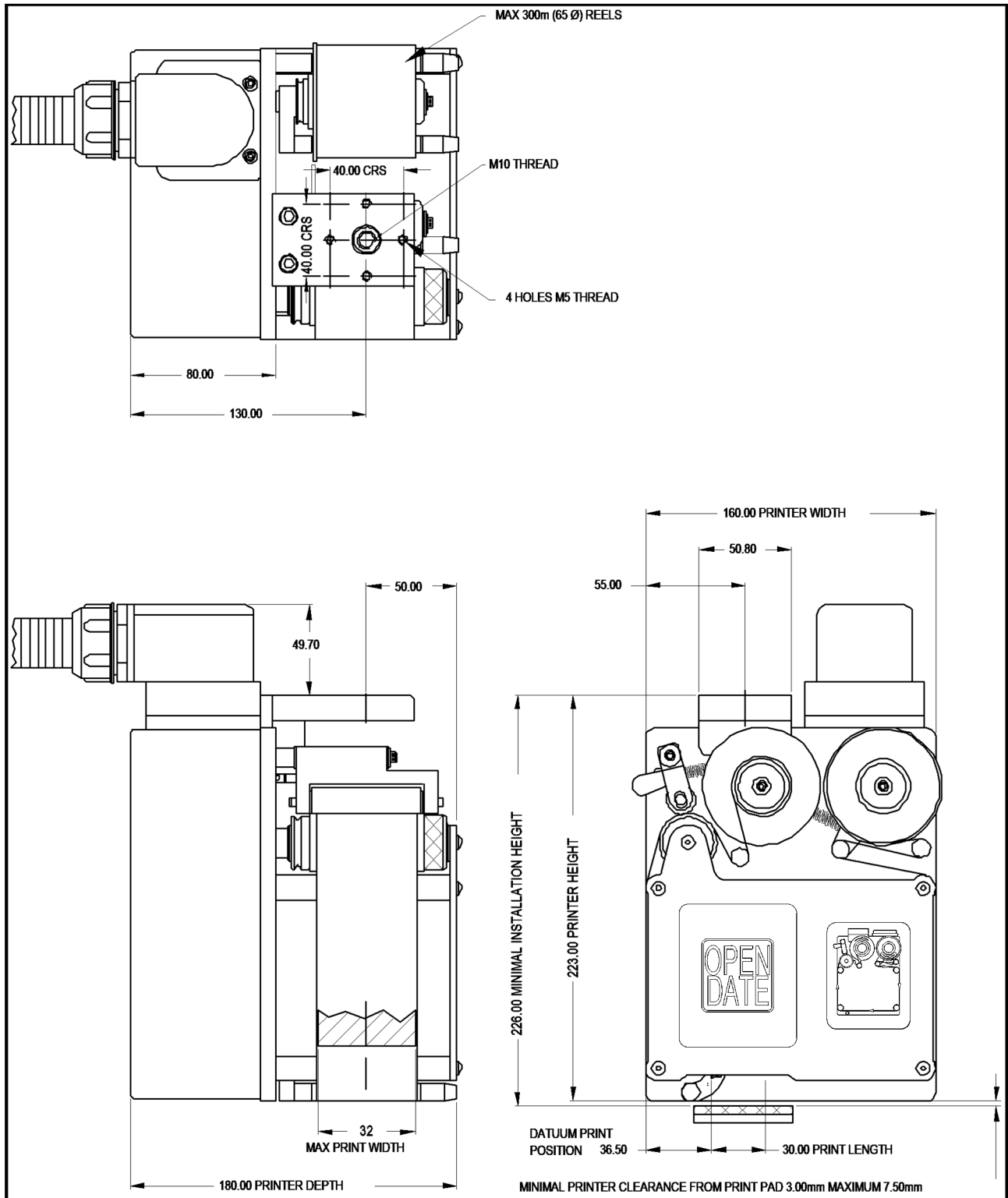

**Power Supply Dimensions & Fixing Points**

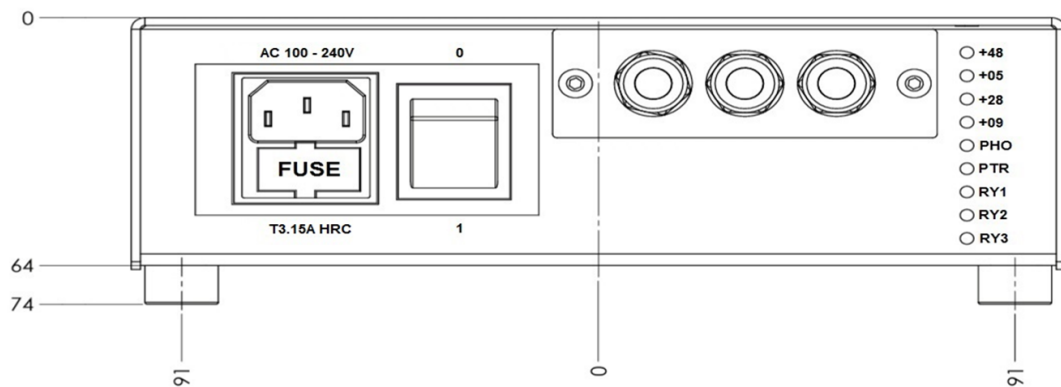
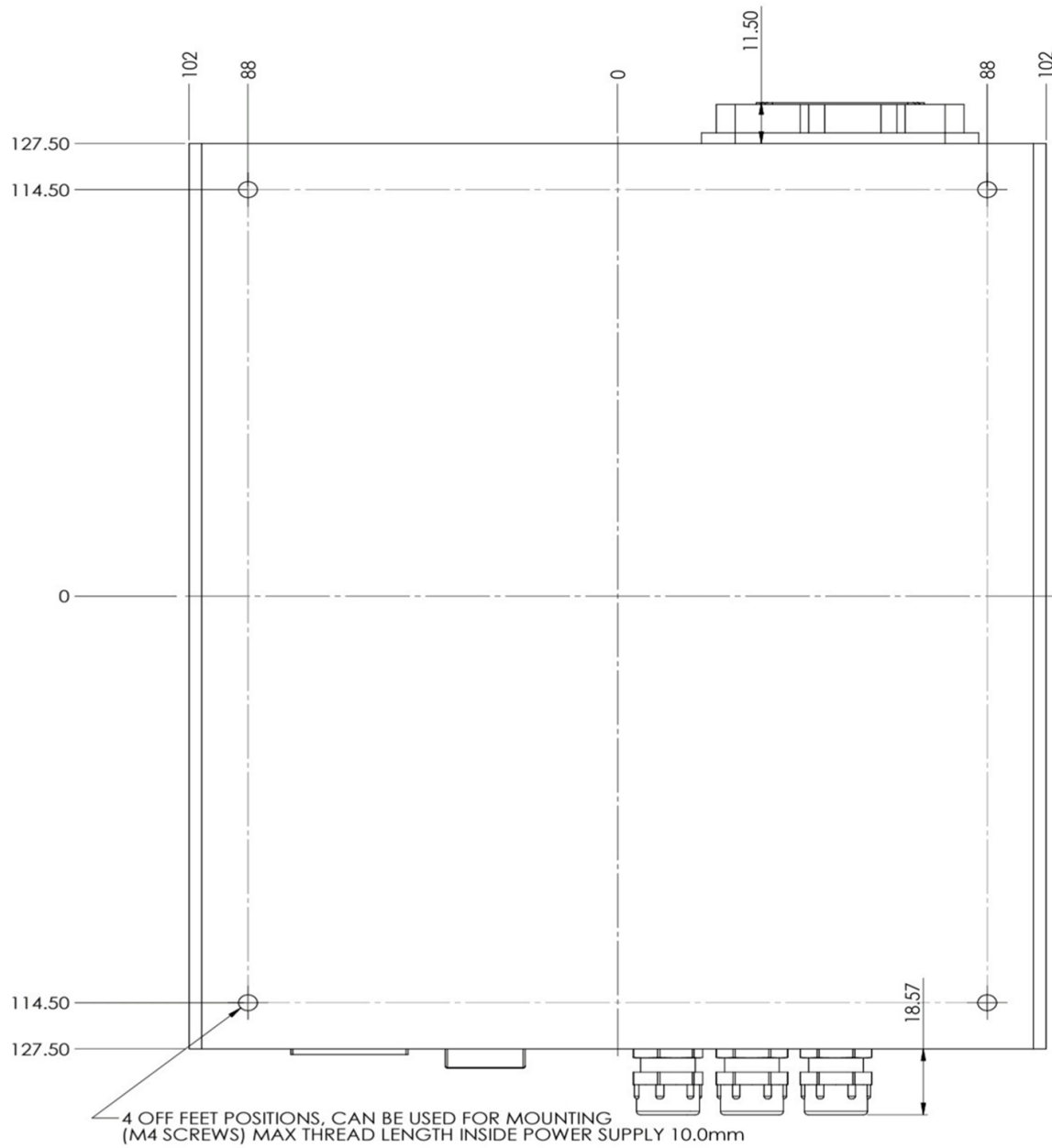

**Open Date Group Companies**

Asia	Open Date Asia Inc Unit 8 Building B Laguna Techno Park Standard Factory Bldg. 2, Phase 7 Laguna Tecnopark - SEZ Binan, Laguna Philippines	Web: <a href="http://www.opendate.com">www.opendate.com</a> Email: <a href="mailto:Cezar.manahan@opendate.co.uk">Cezar.manahan@opendate.co.uk</a> Tel: +63 (0)49 545 1332
France	Open Date France Z.I. D'Attichy No.8, Voie Industrielle 60350 Attichy France	Web: <a href="http://www.opendate.com">www.opendate.com</a> Email: <a href="mailto:info@opendatefrance.com">info@opendatefrance.com</a> Tel: +33 (0)344 42 94 43
Germany	Open Date GmbH Mittlere Stämmig 4 D - 97292 Üttingen Germany	Web: <a href="http://www.opendate.com">www.opendate.com</a> Email: <a href="mailto:info@opendate.de">info@opendate.de</a> Tel: +49 (0)9369/9824-0
USA	Open Date Systems Inc. Springfield Road PO Box 538 Georges Mills NH 03751-0538 USA	Web: <a href="http://www.opendate.com">www.opendate.com</a> Email: <a href="mailto:sales@opendate.com">sales@opendate.com</a> Tel: +1 603 763 3444
UK	Open Date Equipment (UK) Ltd Units 9 Puma Trade Park, 145 Morden Road, Mitcham, Surrey, CR4 4DG	Web: <a href="http://www.opendate.com">www.opendate.com</a> Email: <a href="mailto:sales@opendate.co.uk">sales@opendate.co.uk</a> Tel: +44 (0)20 8655 4999